

Owner's Manual

N°380S
Preamplifier

WARNING: TO REDUCE THE RISK OF FIRE OR ELECTRIC SHOCK, DO NOT EXPOSE THIS APPLIANCE TO RAIN OR MOISTURE.

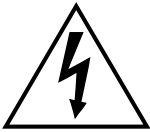
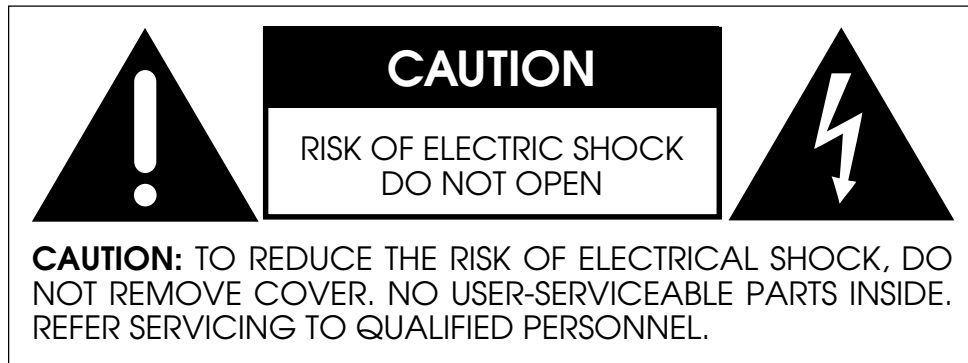

The lightning flash with arrowhead symbol, within an equilateral triangle, is intended to alert the user to the presence of uninsulated “dangerous voltage” within the product’s enclosure that may be of sufficient magnitude to constitute a risk of electric shock to persons.



The exclamation point within an equilateral triangle is intended to alert the user to the presence of important operating and maintenance (servicing) instructions in the literature accompanying the appliance.



Marking by the “CE” symbol (shown left) indicates compliance of this device with the EMC (Electromagnetic Compatibility) and LVD (Low Voltage Directive) standards of the European Community.

NOTICE

This equipment has been tested and found to comply with the limits for a Class B digital device, pursuant to Part 15 of the FCC Rules. These limits are designed to provide reasonable protection against harmful interference in a residential installation. This equipment generates, uses and can radiate radio frequency energy and, if not installed and used in accordance with the instructions, may cause harmful interference to radio communications. However, there is no guarantee that interference will not occur in a particular installation. If this equipment does cause interference to radio or television reception, which can be determined by turning the equipment on and off, the user is encouraged to try to correct the interference by one or more of the following measures:

- Reorient or relocate the receiving antenna;
- Increase the separation between the equipment and the receiver;
- Connect the equipment into an outlet on a circuit different from that to which the receiver is connected;
- Consult the dealer or an experienced radio/TV technician for help.

CAUTION: Changes or modifications to this equipment not expressly approved by the manufacturer could void the user’s authority to operate the equipment.

The information contained in the manual is subject to change without notice. The most current version of this manual will be posted on our web site at <http://www.madrigal.com>.

Important Safety Instructions

Please read all instructions and precautions carefully and completely before operating your Mark Levinson® power amplifier.

1. **ALWAYS** disconnect your entire system from the AC mains before connecting or disconnecting any cables, or when cleaning any component.
2. This product must be terminated with a three-conductor AC mains power cord which includes an earth ground connection. To prevent shock hazard, all three connections must **ALWAYS** be used.
3. AC extension cords are **not** recommended for use with this product.
4. **NEVER** use flammable or combustible chemicals for cleaning audio components.
5. **NEVER** operate this product with any covers removed.
6. **NEVER** wet the inside of this product with any liquid.
7. **NEVER** pour or spill liquids directly onto this unit.
8. **NEVER** block air flow through ventilation slots or heatsinks.
9. **NEVER** bypass any fuse.
10. **NEVER** replace any fuse with a value or type other than those specified.
11. **NEVER** attempt to repair this product. If a problem occurs, contact your Mark Levinson® retailer.
12. **NEVER** expose this product to extremely high or low temperatures.
13. **NEVER** operate this product in an explosive atmosphere.
14. **ALWAYS** keep electrical equipment out of the reach of children.
15. **ALWAYS** unplug sensitive electronic equipment during lightning storms.

From all of us at Madrigal Audio Laboratories, thank you for choosing the Mark Levinson N°380S Preamplifier.

A great deal of effort went into the design and construction of this precision device. Used properly, it will give you many years of enjoyment.

Table of Contents

Unpacking and Placement	6
unpacking	6
installing the batteries in the remote control	6
placement	6
ventilation	6
Operating Voltage	7
A Quick Start	8
Front Panel	9
Rear Panel	12
<i>building a link cable</i>	14
using a turntable	15
<i>tip polarity for external IR input</i>	15
Remote Control	16
Setup and Installation	18
connections and cables	18
setup overview	19
available input names	19
naming an input "EQ"	20
programming input names	20
assigning record outputs	21
results of unrealistic tests	22
programming input offsets	22
programming an automatic output (volume) level	23
programming the mute function	25
volume lock	26
standby timer	27
Operational Modes	28
the monitor mode	28
the record select mode	28
the balance mode	29
balance control tip	30
Using Surround Sound Processors	31
the SSP must not come after the preamp	31
the SSP must not come before the preamp	31
the SSP must not be in a tape loop	32
the SSP & the N°380S	32
wiring diagram using an SSP	33
noise in a/v systems	33
Linked Functions	34
display intensity	34
standby link	34
play link	34
record link	34
Care and Maintenance	35
U.S. and Canadian Warranty	36
90-day limited warranty	36
five year extended warranty	36
Obtaining Service	37
Specifications	38
Dimensions	39

Unpacking and Placement

unpacking

Unpack your N°380S Preamplifier and keep all packing materials for future transport. Locate and remove all accessory items from the cartons. Accessories include:

- | | |
|------------------------------|-------------------|
| 1 90° shielded AC power cord | 1 5/64" Allen key |
| 1 N°380S remote control | 1 1/8" Allen key |
| 2 alkaline batteries | |

Included with your new Mark Levinson preamplifier is a pair of knit, white gloves designed to assist you in the initial unpacking and placement of your new purchase. Please accept them as a token of our appreciation for having purchased one of our products.

installing the batteries in the remote control

Using the supplied 5/64" Allen key, remove the two screws in the bottom end cap of the remote control (*i.e.*, the end opposite the IR transmitter lens). Insert the two alkaline batteries found in the Accessories box, being careful to follow the polarity indications given on the inside of the battery compartment. Replace the end cap and the screws, using the Allen key.

If at some point you notice that your remote control seems not to be performing as well as it once did, its batteries are probably running low. Check the batteries periodically, and replace batteries *before* they are “dead.” (*Fully discharged batteries are prone to leaking corrosive chemicals—the greenish “gunk” you may have seen around battery terminals of other remote controls.*)

placement

The N°380S should be placed close to your source equipment, thus keeping interconnect cabling short. We strongly recommend shelf mounting to allow for proper ventilation.

The N°380S is designed for continuous operation, which is why it features a **standby** mode rather than a full “off” mode—it is designed to be connected to the AC mains at all times for the best performance.

ventilation

Be sure to allow 3 to 4 inches of clearance above the N°380S to allow heat dissipation through air circulation.

Drawings are included in this manual to facilitate special installations and custom cabinetry (see “*Dimensions*”).



Caution!

It is extremely important that all components in your system be properly grounded. Under no circumstances should you defeat a three-prong AC cord with a “ground-lifter” or “cheater” adaptor, as doing so may allow dangerous voltages to build up between components. The presence of these voltages would pose a threat to both your person and your equipment.

Operating Voltage

The N°380S Preamplifier is set at the factory (internally) for 100V, 120V, 200V, 230V, 220V, or 240V AC mains operation @ 50 or 60Hz. (*230V/50Hz only in European Union countries, in compliance with CE regulations.*) This voltage setting cannot be changed by the user.

Make sure that the label on the bottom panel of the N°380S (adjacent to the AC cord) indicates the correct AC operating voltage for your location.

If the voltage indicated on your N°380S is incorrect, or if you wish to change the AC operating voltage of your N°380S as the result of moving to a different country than the one in which you purchased your digital audio processor, see your Mark Levinson dealer.

The N°380S is easily powered by a normal 15-ampere AC mains line. If other devices are also powered from the same AC line, their additional power consumption should be taken into account.

A Quick Start...

We recognize that many people are understandably eager to begin listening to their new components, and that reading the manual is often done (if at all) at a later time—perhaps while listening to music through the new product itself. We *strongly recommend* that you read this manual thoroughly, as the N°380S Preamplifier incorporates many unusual features which enhance its operation.

Fortunately, we can help you get some music up and running on your system quickly, so that you may begin enjoying your new preamplifier while reading more about it. The goal here is simply to make some music quickly. (*The following procedure assumes that the rest of your system is already connected; e.g., power amplifier to speakers, etc.*)

1 TURN OFF YOUR ASSOCIATED COMPONENTS

This minimizes the opportunity for a momentary electrical surge to disturb your system while making connections. If you have a large power amplifier, allow its power supply to fully discharge before proceeding.

2 CONNECT A SOURCE TO INPUT 1 (INPUT 3 IF SINGLE-ENDED)

Connect the output of your CD player to the Left and Right Input 1 XLR jacks on the rear panel of your N°380S preamplifier. (*Use the Input 3 RCA jacks if your source is single-ended. If used, press the Input 3 button on the face of the N°380S to select this input.*) High quality interconnecting cables such as Madrigal CZ Gel will yield superior results, and are strongly recommended.

3 CONNECT THE N°380S OUTPUTS TO YOUR POWER AMP

The Left and Right Main Out jacks on the rear panel of the N°380S should be connected to the corresponding inputs of your power amplifier. If your power amplifier has balanced inputs and you have appropriate high-quality cables (with XLR plugs at both ends), we recommend using the Balanced Main Outs. Otherwise, use the (single-ended) Main Outs from the preamplifier to your power amplifier. Once again, high quality interconnecting cables such as Madrigal CZ Gel will yield superior results, and are strongly recommended.

4 PLUG THE N°380S INTO THE WALL OUTLET

Connect the AC cord to the male IEC connector on the center of the bottom panel of the N°380S, then connect the AC cord to the AC mains. When power is first applied, the N°380S will initialize (showing all current input names), automatically select the first available input (CD1), and set its output level to **OFF**. (If you used input 3, select it now.)

5 TURN ON YOUR SOURCE COMPONENT; TURN ON YOUR POWER AMPLIFIER; SLOWLY RAISE THE VOLUME ON THE N°380S TO A COMFORTABLE LEVEL

Congratulations! You should now be able to enjoy your favorite music while reading the rest of this manual.

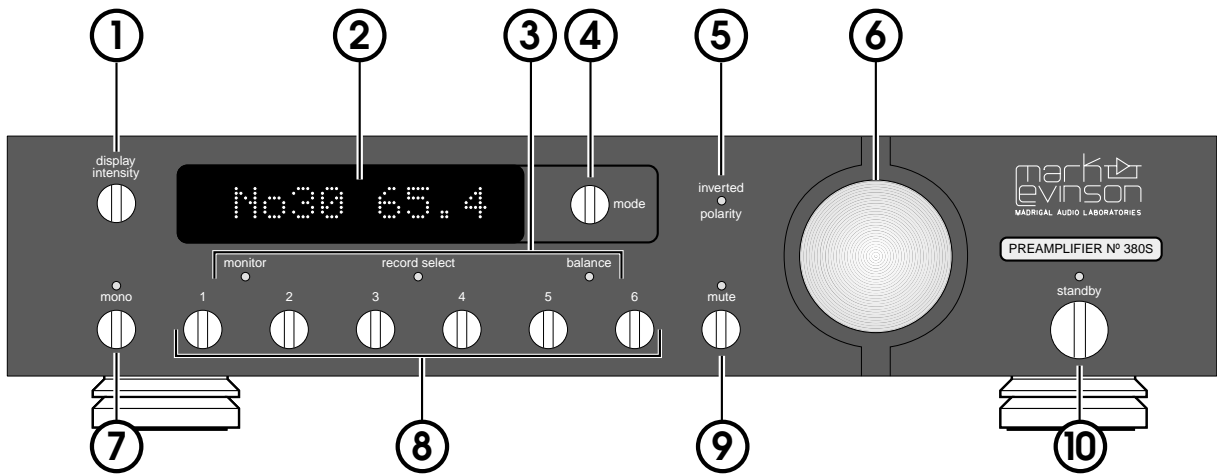

Front Panel

1 DISPLAY INTENSITY BUTTON

Cycles among four levels of brightness (including “off”) for the display, allowing adjustment for various ambient lighting conditions. When “off,” the display will turn on for a few seconds whenever a setting is changed. When used in conjunction with certain compatible Mark Levinson components, this button will control the display intensity of all linked components. (For more information, see “*Linked Functions.*”)

2 ALPHANUMERIC DISPLAY

Provides a wide range of information concerning the operational status of the N°380S. The information displayed depends on the operating mode the N°380S is in (determined by the **mode** button). The information displayed is summarized below:

monitor	Selected (audible) Source and Volume
record Select	“RECD” and Source to be recorded
balance	Direction and Magnitude of Offset

In addition, when used with Mark Levinson power amplifiers that incorporate our communications link circuitry, this display is used to indicate the presence of a fault condition (if any) in the amplifier. Please refer to the owner’s manual of your amplifier for more information. For more detailed information on the preamplifier’s use of this display, see “*Operational Modes.*”

3 MODE INDICATORS

Three LEDs give visual confirmation of the operational **mode** the N°380S is in at any moment. When the **balance** control of the N°380S is “off-center,” the **balance LED** remains lit as a reminder, in addition to other **mode indicators** that might be on to indicate either **monitor** or **record select**.

4 MODE BUTTON

Cycles among the three primary operational **modes** of the N°380S: **monitor** (the source being listened to); **record select** (the source being provided to the Record Outputs); and **balance** (the relative volumes of the Left and Right channels). Confirmation of these operating modes is given by the **mode indicators** below the **alphanumeric display**. (See 3, above.)

5 INVERTED POLARITY INDICATOR

The **polarity** (sometimes inaccurately called “absolute phase”) of the output of the N°380S may be inverted via the N°380S remote control, in which case this LED will light as confirmation. A second press of the **polarity** button on the remote control will restore the polarity of the output to its original, non-inverted state.

6 VOLUME KNOB

This control is normally used to adjust the listening volume, and does not effect the level of the signal being sent to the Record Outputs. When in **balance** mode, this knob is used to vary the relative output of the Left and Right channels. It is also used during setup for various adjustments; see “*Setup and Installation*.”

7 MONO BUTTON

This button toggles between **stereo** and **mono** operation. When in mono, it activates circuitry which combines left and right input signals, and sends the resulting monophonic signal to *both* left and right outputs. This circuit is particularly useful when listening to older, monophonic source material, since significant noise reduction is often realized by listening to mono recordings in mono.

8 SOURCE SELECTOR BUTTONS

Inputs 1–6 are selected by pressing their respective buttons. When in the **monitor** mode, pressing one of these buttons will select the source to be heard (*i.e.*, sent to the main outputs); when in **record select** mode, pressing one of these buttons will select the source to be recorded (*i.e.*, sent to the record outputs).

9 MUTE BUTTON

Pressing the **mute** button will reduce the main output level of the preamplifier by a user-modifiable amount, ranging from 1 to 60 decibels. Pressing the Mute button a second time without adjusting the volume will return it to its previous setting.

If you adjust the volume with either the volume knob or the remote control while **mute** is engaged, the preamplifier will adjust its volume *from the muted volume* and *disengage* the **mute** function. (This to prevent an unpleasant surprise when, having increased the volume while muted, someone un-mutes the system.)

The factory default setting of the Mute circuit is -20 dB. (See “*Setup and Installation*” for information on changing the factory default setting.)

10 **STANDBY BUTTON**

Toggles the N°380S between normal operation and **standby**, wherein the display is turned off, the outputs are disconnected, and all controls are inoperable. All critical circuitry remains powered-up during **standby** to ensure immediate, optimal performance when you are ready to listen to music.

The LED above the **standby** button will blink slowly when the N°380S is in **standby**, indicating that power is still being provided to the unit. (If the N°380S is Linked to other Mark Levinson components which are also in **standby**, they will blink in unison.)

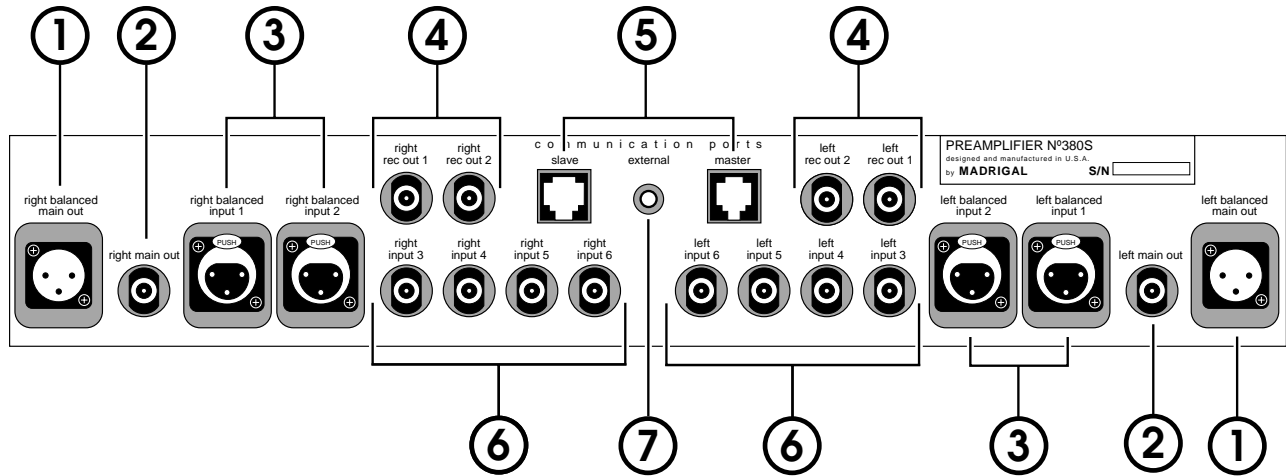

Rear Panel

Note: All left-channel inputs and outputs are on the left of the rear panel *as seen from the front*, and all right-channel inputs and outputs are on the right of the rear panel *as seen from the front*. This design minimizes any possible confusion when changing connections once the unit is installed, while also maximizing channel separation in this dual monaural preamplifier.

1 BALANCED MAIN OUTPUTS

If your power amplifier is equipped with balanced (sometimes called “differential”) inputs, it is best to use these balanced outputs on your N°380S. A balanced signal from preamplifier to power amplifier will offer the highest possible performance with the best immunity from common-mode noise, such as radio frequency interference (RFI). The balanced output signal is made available by way of precision male XLR connectors (requiring female XLRs on the preamplifier end of the interconnecting cable).

The pin assignments of these XLR-type male outputs are:

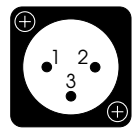

- Pin 1: Signal ground
- Pin 2: Signal + (non-inverting)
- Pin 3: Signal – (inverting)
- Connector ground lug: chassis ground

Refer to your power amplifier’s operating manual to verify that the pin assignments of its input connectors correspond to the N°380S. If not, wire the cable so that the appropriate output pin connects to the equivalent input pin.

Connect the right-channel and left-channel **balanced main** outputs of the N°380S to the appropriate balanced inputs of the power amplifier.

If your system calls for multiple outputs from the N°380S (as might be the case for “passive” bi-amplification, for example), you may use balanced Y-adapters to split each balanced output into two balanced outputs. The low output impedance (6Ω) of the N°380S can easily drive multiple power amplifiers.

2 SINGLE-ENDED MAIN OUTPUTS

Single-ended (“unbalanced”) outputs using Madrigal-designed RCA jacks are provided for compatibility with a wide range of associated components, including power amplifiers and electronic crossovers.

If you use the single-ended outputs, connect them to the corresponding inputs of your power amplifier (or other device). Note that special features of the N°380S enable it to be used optimally with a surround sound processor as one of its *inputs*. We do not recommend having a surround sound processor follow the N°380S in the signal path. (For more information, see “Using Surround Sound Processors.”)

3 BALANCED INPUTS 1 AND 2

Accepts right-channel and left-channel balanced signals from source equipment with balanced outputs.

The pin assignments of these XLR-type female input connectors are:



- Pin 1: Signal ground
- Pin 2: Signal + (non-inverting)
- Pin 3: Signal – (inverting)
- Connector ground lug: chassis ground

Refer to the operating manuals of your balanced-output line-level sources to verify that the pin assignments of their output connectors correspond to the N°380S. If not, wire the cables so that the appropriate output pin connects to the equivalent input pin.

Note:

If you won't be using the N°380S' balanced inputs and need more single-ended inputs, it is possible to fabricate a cable to connect line-level sources with single-ended output to these balanced inputs:

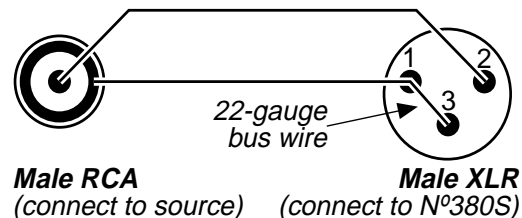

4 RECORD OUTPUTS

Connect these outputs to the right-channel and left-channel tape inputs of your recorder. Make a note of which set of **record outputs** you used with which recording device. It is important to name the inputs you use and to associate the correct **record output** with the appropriate recording device. By giving the N°380S this information, it can prevent accidental record loops that might otherwise create disturbing feedback. (See “programming input names” and “assigning record outputs” on pages 20-21.)

These outputs are unaffected by the **output level** control on the front panel of the N°380S, or by the source chosen to be monitored.

5 SLAVE AND MASTER COMMUNICATOR PORTS

These communications ports allow the N°380S to “link” to certain compatible Mark Levinson components. (See “Linked Functions.”)

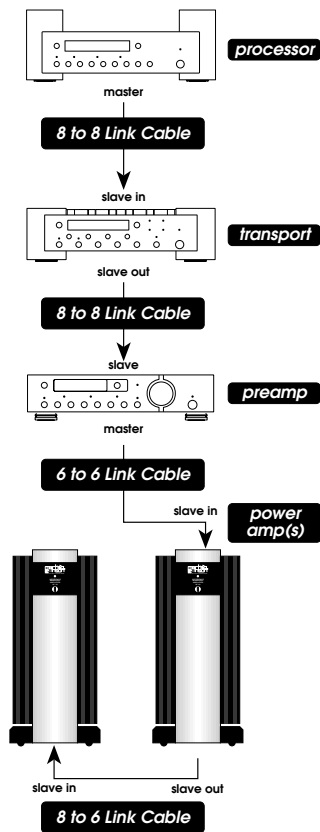

building a link cable

The Mark Levinson Linking system uses a Digital Audio Processor as the Master of (and central clearinghouse for) inter-component communications. Other components such as digital transports are connected to the Master as “Slaves,” and can be “daisy-chained” using their Slave In and Slave Out jacks. As the ultimate destination of all source signals, the N°380S Preamplifier *must* be the final “Slave” in the chain. (In technical terms, it terminates the communications bus.) In turn, the N°380S can serve as a master to an associated compatible Mark Levinson power amplifier—hence its “Master” communications port.

Thus, if the only other Mark Levinson Link-compatible component you have is a digital audio processor, connect its **master** port to the N°380S’ **slave** port using a “straight-through” RJ-45 cable. If there are additional Mark Levinson Link-compatible components in the system, place the N°380S at the end of the chain by connecting the last **slave out** port to the N°380S’ **slave** port. See the diagram (left) for clarification.

The RJ-45 cable needed for the Link connection between source components and the preamplifier may be purchased from your Mark Levinson dealer. It may also be easily and inexpensively made to length using two RJ-45 connectors and the appropriate length (up to 100 feet/30 meters) of RJ-45 (flat, eight conductor) cable.

RJ-45 cables and connectors are used throughout the world for both telecommunications and computers, and are widely available at low cost. The connectors are crimped on to the ends of the cable such that pin 1 at one end is connected to pin 1 at the other end. Such a “straight-through” connection is (counter-intuitively) made by introducing a 180° twist in the cable between the two ends, as shown below.

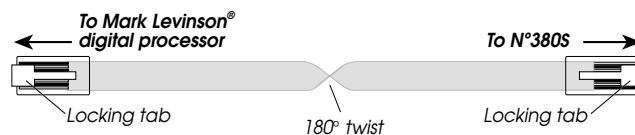

The power amplifier Link connection is made using a 6-conductor Link cable. Connect the N°380S’ **master** port to the **slave** port of a compatible Mark Levinson power amplifier.

Warning!

Connecting the communication ports other than as described in this manual can damage the N°380S and the associated Mark Levinson components, and will void those products' warranties.

using a turntable

6 INPUTS 3-6

Accepts right-channel and left-channel (single-ended) inputs from line-level source equipment such as tuners, CD players, and tape decks.

If a turntable is to be used with the N°380S, it must be used in conjunction with a phono preamp such as the Mark Levinson N°25. The phono preamp used should provide RIAA equalization and deliver a line-level signal to the input of the N°380S (both standard functions of a phono preamplifier)..

7 EXTERNAL IR INPUT

The N°380S incorporates an infrared repeater input to facilitate a wide range of installation options. If desired, the N°380S may be placed inside a cabinet or outside the normal line-of-sight in the listening area, with the controlling IR signal being relayed to the N°380S by any of a number of commercially-available IR repeaters.

The specifications for this IR input call for a triggering voltage of 5 volts at no more than 100 milliamps of current, with the tip of the 1/8" mini-plug having positive polarity, as below:

tip polarity for external IR input

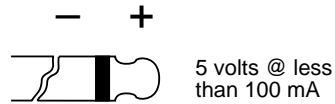

If you would like more information on the possibility of using an infrared repeater with your N°380S, please contact your Mark Levinson dealer.

Remote Control

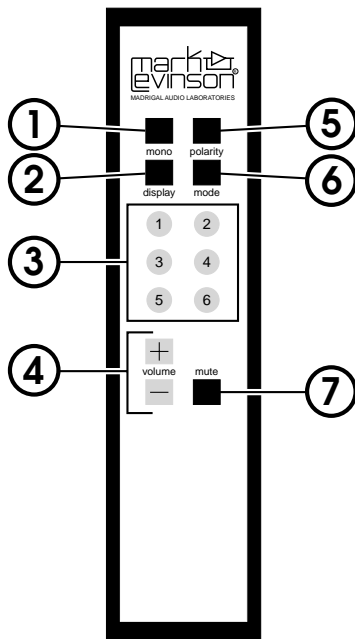

1 MONO

Pressing this button will toggle the N^o380S in and out of the **mono** mode, having the same effect as pressing the front panel **mono** button. Mono mode activates circuitry which combines Left and Right input signals, and sends the resulting monophonic signal to *both* Left and Right outputs. This circuit is particularly useful when listening to older, monophonic source material, at which time significant noise reduction may be realized.

2 DISPLAY

Duplicates the function of the **display intensity** button on the front panel, cycling among four levels of brightness (including “off”) for the display, allowing adjustment for various ambient lighting conditions. (*Tip: If pressed and held for several seconds, the display button will place your N^o380S in Standby.*)

3 SOURCE SELECTION

These buttons provide remote selection of the six inputs of the N^o380S. Pressing any of these buttons (or the **volume +/-** buttons) while the N^o380S is in standby will bring it fully on and operational. These buttons are gray instead of black to serve as a reminder of this secondary function.

4 VOLUME +/-

Raises the volume at either low speed for fine adjustments or high speeds for larger changes. The N^o380S will slowly raise its output for the first 1.5 seconds this button is depressed, then move to higher rates of change.

Pressing either **volume +/-** button while the N^o380S is in standby will bring it fully on and operational. These buttons are gray instead of black to serve as a reminder of this secondary function.

Note that all volume and balance functions are disabled if a surround sound processor [“ssp”] input is selected. For more information on this special feature of the N^o380S’ design, see “Using Surround Sound Processors.”

5 POLARITY

Inverts the **polarity** (sometimes inaccurately called “absolute phase”) of the outputs of the N^o380S. A second press of this button will restore the outputs to their original, non-inverting polarity.

6 MODE

Duplicates the function of the Mode button on the front panel, cycling through **monitor**, **record select**, and **balance** modes. As with the front panel button, use it in conjunction with the Source Selection buttons when in either **monitor** or **record select** mode and with the **volume +/-** buttons when in **balance** mode.

7 MUTE

Toggles between normal output level and the user-programmable **mute** function, reducing the level by 1 to 60 decibels (depending on the user's programming). The factory default setting gives a 20 decibel reduction in output.

Setup and Installation

connections and cables

The N°380S incorporates both RCA-type and XLR-type connectors for audio signal input and output.

The Madrigal-designed RCA-type connectors used for single-ended audio interconnection are a great improvement over ordinary RCA-type connectors, offering superior contact integrity and mechanical locking when used in conjunction with the Madrigal cable-mounted RCAs. The gold-plated XLR-type connectors used for balanced connections are made to professional application standards.

When connecting the N°380S to source equipment and power amplifiers, we recommend Madrigal Audio Laboratories CZ Gel Interconnect Cable. CZ Gel is available in various lengths, in purpose-designed balanced and single-ended configurations. See your Mark Levinson dealer for more information.

Connect the AC cord to the male IEC connector on the center of the bottom panel of the N°380S, then connect the AC cord to the AC mains.

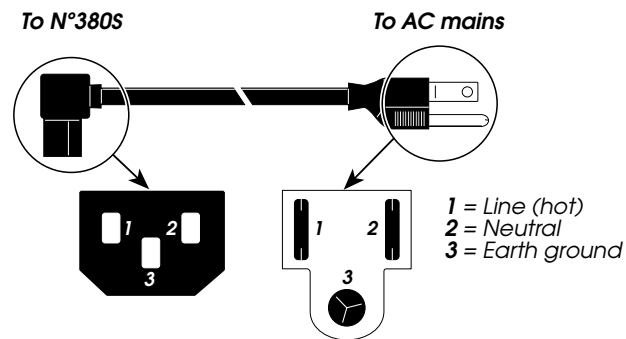

When power is first applied to the N°380S, the preamp will run through an automatic initialization sequence which (among other things) provides a “role-call” of the current input names (see “Names” on the next page), selects the first name *other than* **NOT USED** or **ssp**, and sets the volume to **OFF**.

For optimal sonic performance and longevity, the N°380S is designed to remain powered at all times (the **standby** switch merely mutes the preamplifier’s outputs and turns off the display). There is an initial break-in period of approximately 300 hours before the N°380S achieves optimum performance.

Note:

If AC mains power to the N°380S is interrupted, the main output will be muted. When power is restored, the initialization sequence described above will restore the preamplifier to normal operation, with the main output muted and the display indicating OFF.

We recommend you allow the circuitry within your various system components to stabilize for 1 to 2 minutes before use after such a power outage.

setup overview

The N°380S Preamplifier has many provisions for custom-tailoring the system's operation to match your preferences. The consistent method for modifying any of these settings is to enter a **setup** mode by:

- pressing and holding a button for several seconds;
- the setting is then modified, either by pressing a button or turning the volume knob;
- and then the new preference is confirmed by pressing and holding the original button again for several seconds.

This three-step process is simple and logical, yet provides positive feedback that your change has been accepted and saved for future use. (If you allow the preamp to “time out” after changing something, your change will still be saved.)

To facilitate operation in complex multisource systems, the N°380S is capable of displaying a wide variety of names for each of its six inputs. The available names are listed below.

available input names

NOT USED	<i>(any unused input)</i>
ssp	Surround Sound Processor
EQ	Equalizer
DAT	Digital Audio Tape
VCR	Video Cassette Recorder
CAS	Cassette
RTR	Reel-To-Reel
DCC	Digital Compact Cassette
MD	Mini-Disc
CDR	Compact Disc, Recordable
CDI	Compact Disc, Interactive
SAT	Satellite
PH	Phono
LD	LaserDisc
CD	Compact Disc
TUN	Tuner
AUX	Auxiliary
DAC	Digital to Analog Converter
DMX	Digital Music Express™ (a cable radio system)
CDP	Proceed™ CD Processor
DVD	(depends on who you ask...)
DAP	Proceed DAP
No30	Mark Levinson N°30(.5) Digital Audio Processor
No35	Mark Levinson N°35 Digital Audio Processor
No36	Mark Levinson N°36(S) Digital Audio Processor
No39	Mark Levinson N°39 CD Processor

Each name is normally followed by a number corresponding to the number of the input being used. (The exceptions being the names like “No30” and “No35” for the corresponding Mark Levinson products.) Thus, a DAT in Input 3 would normally display a **DAT3**. In this way, you can have more than one CD player, for example, and still tell at a glance which one is selected.

There is also a special name to indicate that an input is **NOT USED**.

The factory default input name is **NOT USED** for each input except **CD1** and **CAS3** (for “*cassette in input 3*”, the most common recording device); these were configured for the Quick Start portion of this manual. Any or all input names (including these) may be changed easily to match the configuration of your particular system.

naming an input “EQ”

The **EQ** name also deserves special mention: if your loudspeaker requires a dedicated equalizer for proper operation (or if you have any other reason for using an EQ much of the time), you may connect the outputs of the equalizer to the input named “EQ.” By “recording” the source you wish to listen to (selecting it on the **record** path), and monitoring the EQ input (selecting EQ on the **monitor** path), you will be able to run all signals through the equalizer prior to listening to them. This is usually preferable to simply placing the EQ between the preamp and the power amp, as most equalizers perform best at a (fixed) line level—which is what they will receive in this hookup.

Since, in this scenario, you would spend most of your time in the **record** path (selecting the source to be equalized) rather than the **monitor** path, we have enabled the volume control function in the **record** path *when the input selected on the monitor path is named EQ*. Thus, you may adjust the volume of the selected source without having to push the **mode** button twice to return to the **monitor** path.

programming input names

To change the name of any particular input, follow these steps:

1 IN THE MONITOR MODE, SELECT THE INPUT YOU WISH TO RENAME

2 PRESS AND HOLD THE MODE BUTTON...

on the front panel until the display reads SET DATA, as below:



3 RELEASE THE MODE BUTTON; PRESS THE CHOSEN INPUT BUTTON REPEATEDLY...

until the Name you desire appears in the display.

4 PRESS AND HOLD THE MODE BUTTON AGAIN...

until the display reads **NEW DATA**, as shown below. (**Note:** see Step 5 below if you have selected an name of a device capable of recording.) This indicates that your new name for that input has been stored in nonvolatile memory. As a result, this new setting will survive power outages and other interruptions of AC power to the preamp.

assigning record outputs



5 IF THE SOURCE IN QUESTION IS A RECORDABLE DEVICE...

You will be further prompted to associate a particular **record output** with this particular device. Instead of showing “**NEW DATA**,” the display will read “**RCD: NONE**” as shown below.



You may elect not to use either **record output** with this particular device, as may be the case if you have several devices in your system that are capable of recording. In this case, leave the display on “**RCD: NONE**” and move to Step 6.

You may also select either **record output 1 or 2** to be associated with this particular input. To do so, press the input button repeatedly until you see your choice of **OUT1** or **OUT2** in the display. (**OUT1** is given as an example below.)



6 STORE YOUR SELECTION

Save your choice in nonvolatile memory by pressing and holding the Mode button until the display reads **NEW DATA**, as below.



results of unrealistic tests

The N°380S Preamplifier has been optimized to yield optimum sonic performance under normal, real-world operating conditions. This approach involves no disadvantage when the unit is used as designed.

Unrealistic tests such as listening at full gain to an *unterminated input* which has been associated with an *unterminated record output* may result in some small amount of noise at the main output which does not occur when the N°380S is used correctly. Moreover, even under these unrealistic test conditions, any resulting noise is small and poses no danger.

Rather than compromise the sonic performance of the preamplifier in an effort to eliminate even the remote possibility of this noise being detected, the setup procedure outlined above for programming input names was designed to make it virtually impossible to create a condition under which any such noise can be heard. We recommend using the input name **NOT USED** for all unused inputs.

programming input offsets

The N°380S allows you to adjust the relative outputs of your various sources with respect to one another, so as to avoid disturbing and/or potentially dangerous changes in output levels as you switch from one source to the next. These **input offsets** are made relative to whichever source tends to be the loudest—that is, you raise the outputs of the remaining sources to match that of your loudest source. This is achieved as follows:

1 DECIDE WHICH SOURCE HAS THE HIGHEST OUTPUT

You should listen to several examples of each source before you decide (e.g., to several different CDs when evaluating your CD player's output, or to several radio stations when evaluating your tuner's output). The point is to ascertain whether any source *consistently* plays more loudly than others, and to bring the others up to its level. (For example, other things being equal, balanced outputs of components are usually approximately 6 dB stronger than the single-ended outputs.)

2 LISTEN TO THIS SOURCE LONG ENOUGH TO ESTABLISH ITS VOLUME

Use a particular output level setting to which you can easily return, such as 60.0 in the display. Develop a sense of the perceived volume at this setting, which you will want to match with your other inputs. Optionally, you may desire to measure its actual output at your chosen volume setting with a sound pressure level (SPL) meter set to "Slow" or "Average" response.

3 SELECT THE FIRST OF THE SOURCES WHOSE OUTPUT YOU WILL RAISE

While music is playing from both your reference, "loudest" source and the source you are about to adjust, select the latter so as to give you a sense of the magnitude of the adjustment you are about to make.

4 PRESS AND HOLD THE MODE BUTTON ON THE FRONT PANEL

After a few seconds the display will change to show **SET DATA**, as below. Release the **mode** button.



5 RAISE THE VOLUME TO MATCH YOUR REFERENCE

Using the volume knob, raise the volume of your “quieter” source until it subjectively matches the volume level of your “loudest” source. The display will show the name of the input you are adjusting and the degree of additional output you are assigning to it, measured in decibels (0.0 to 20.0 dB in tenths of a decibel).

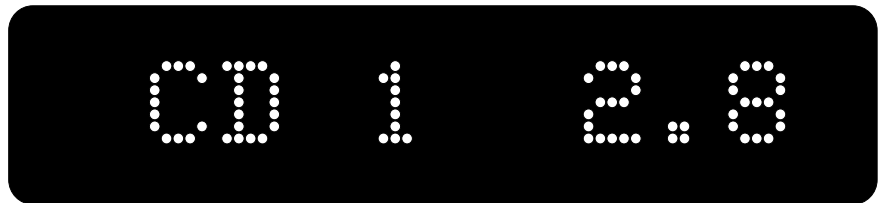

Note that “CD 1” in the example given above represents the currently chosen input, and “2.8” indicates the current offset for that input.

6 PRESS AND HOLD THE MODE BUTTON AGAIN...

until the display reads **NEW DATA**, as below.



This indicates that your new **input offset** has been stored in nonvolatile memory. As a result, this new setting will survive power outages and other interruptions in AC power to the preamp. You may wish to repeat this process in order to refine your settings.

**programming an automatic
output (volume) level**

The N°380S also features the ability to remember a “preferred” output level setting, to which it will return whenever you select a particular input. This capability is a great convenience when used with tuners, for example, since their output level is often more consistent than other sources, and since tuners may be used primarily for background (rather than critical) listening. This adjustment may be made for each input independently of any other input.

In order to take advantage of this **automatic output level** setting, follow the steps below:

1 SELECT THE INPUT WHOSE LEVEL YOU WOULD LIKE TO “AUTOMATE”

2 ADJUST THE VOLUME TO YOUR PREFERRED LEVEL

This will be the preferred, programmed level.

3 PRESS AND HOLD THE MODE BUTTON ON THE FRONT PANEL

Hold the mode button until the display reads “**SET DATA**,” as below:



4 TURN THE VOLUME KNOB COUNTERCLOCKWISE FROM 0.0 UNTIL THE DISPLAY READS “AUTO”

The display will initially look like the illustration below:



When the volume knob is rotated counterclockwise, the display will change to resemble the illustration shown below:

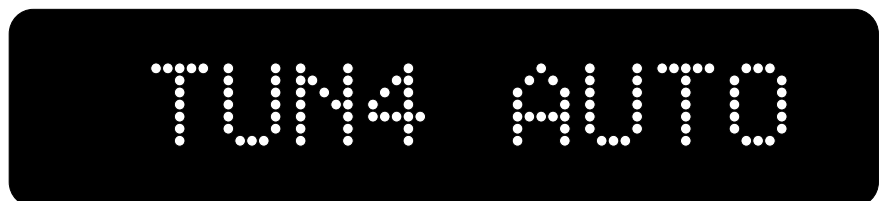

In effect, you are setting the **input offset** of this input to remember an *absolute* volume setting (whatever it was before you held the **mode** button down) rather than a *relative* setting (that is, relative to the current playback volume).

5 PRESS AND HOLD THE MODE BUTTON AGAIN...

until the display reads **NEW DATA**.



This indicates that your new **automatic output level** has been stored in nonvolatile memory. Your N°380S will now automatically return to this volume setting whenever this input is selected. To reverse this situation, simply readjust the **input offset** as described above (in “*programming input offsets*”).

Note:

It is necessary for the N°380S to have an Input Offset of 0.0 in order to access the AUTO setting. As a result, it will be necessary to save a 0.0 Input Offset before selecting AUTO if a higher offset was previously saved.

**programming the
mute function**

The N°380S provides a user-defined **mute** function which quickly reduces the output level by a predefined amount between 1 and 60 decibels. The factory default setting is -20 dB.

If you regularly listen at relatively high sound pressure levels, you may wish to increase the magnitude of the change brought about by engaging the **mute** button. For example, a -20 dB change from an average of 95 dB SPL would bring the volume in the room down to 75 dB SPL. If used in response to the telephone ringing, you would probably find 75 dB SPL of music in the background too loud for a comfortable telephone conversation.

To alter the change introduced by the Mute function:

1 PRESS AND HOLD THE MUTE BUTTON

Wait until the display reads “**MUTE**” and a number (which will read “-20” as delivered from the factory).



2 ADJUST THE VOLUME KNOB TO YOUR PREFERRED SETTING

You may select any value between -1 and -60 decibels (inclusive), in one-decibel increments.

3 PRESS AND HOLD THE MUTE BUTTON AGAIN

When the display reads **NEW DATA**, the N°380S will have saved your new setting in nonvolatile memory.



The **mute** button will toggle you back and forth between the “normal” playback level and a level which is as many decibels below that level as you have elected to use as your **mute** function.

However, if you adjust the volume with either the volume knob or the remote control while in the **mute** mode, the preamplifier will adjust its volume *from the muted volume* and *disengage* the **mute** function. This design guards against unexpected (and possibly unpleasant) large increases in volume when the **mute** button is disengaged after raising the volume with the knob.

volume lock

The N°380S also allows a “maximum volume setting” to be established. Using this feature, it now becomes possible to “lock out” volume settings above a certain point in the preamplifier’s range.

In systems that have highly sensitive loudspeakers, the available +18.9 dB of gain may allow the system to be driven to dangerously loud levels. Alternatively, the presence of children in the home may lead the owner of the system to desire some restriction on how loudly it can be played.

In either case, setting the maximum volume is quite simple:

1. **TURN THE VOLUME TO THE DESIRED “MAXIMUM VOLUME”**
2. **PRESS AND HOLD THE MONO BUTTON UNTIL THE DISPLAY READS LOCK SET**

The display will time out after a few seconds and revert to its normal display, except that it will no longer allow you to exceed the chosen maximum volume. (*Exception: the SSP mode will still override this feature and pass the surround processor’s front channels through at unity gain, regardless of the setting of the Volume Lock.*)

If and when you want to restore the volume control to its normal, full range operation, simply press and hold the **mono** button again to toggle back into the nor-

mal volume mode of operation. The display will read **LOCK OFF** to indicate the return to normal operation.

standby timer

In a similar fashion, you may elect to have the preamplifier (and the entire system, if Linked) go into **standby** after a certain period of time, much like a “Sleep Timer” on many alarm clocks. To engage the **standby timer** on the N°380S:

1. PRESS AND HOLD THE STANDBY BUTTON UNTIL THE DISPLAY READS TIME OFF.

2. TURN THE VOLUME KNOB TO SELECT A TIME BETWEEN 1 AND 120 MINUTES.

An example might be: **TIME 60** would turn off the system in an hour.

3. THE DISPLAY WILL NOW TIME OUT AND RETURN TO NORMAL

The preamp (or entire Linked system) will go into **standby** at the appointed time one time only (so you don't have to live with the product turning itself off every 60 minutes thereafter...).

Operational Modes

the monitor mode

The majority of time you spend with your N°380S will be spent in the **monitor** mode. In this mode, the display indicates the name of the input you have selected and the listening volume (in decibels). The output control acts as a volume knob, increasing or decreasing the volume in 0.1 dB increments above 39.0 (with gradually increasing increments below this low level). The **input selection** buttons select the source to be listened to at any point in time. In short, in the **monitor** mode, the N°380S acts precisely as you would expect a preamplifier to act.

There are several refinements which may not be immediately apparent to the casual user, however. When turned quickly by hand, the effect of the **output control** will accelerate (*i.e.*, yield a greater change per revolution of the knob) so as to reach your preferred volume more quickly. Conversely, when the knob is turned slowly, the volume changes at maximum resolution to facilitate fine adjustments and precise level control (0.1 dB through most of the range).

However, if the volume knob is spun quickly (as though it were a flywheel), the rate of change will *decrease* again. This design helps avoid accidental bumps of the preamplifier's Output Level knob sending potentially dangerous signal levels to your loudspeakers.

Lastly, the corresponding buttons on the **remote control** behave in a similar fashion when in the **monitor** mode. If the **volume +/-** buttons are held for more than approximately 1.5 seconds, the N°380S infers that you would like to change volume more quickly and accelerates the volume change.

While in the **monitor** mode, the **input selector** buttons choose the source which will be heard over the loudspeakers.

the record select mode

When you wish to send a signal out to be recorded, push the **mode** button once to enter the **record select** mode. In this mode, the display indicates "RECD" on the left side and the name of the input currently being supplied to the Record Outputs on the right. An example is given below:



To select a different input for recording, simply press the appropriate Input Selection button while in this mode. Note that the N°380S will not allow a recording device to serve as its own source while monitoring itself, as this would allow potentially dangerous feedback to be reproduced by the loudspeakers. (See "*programming input names*" for more details.)

The **record outputs** may be disconnected (or “defeated”) by pressing the **input selector** button of the currently selected (to-be-recorded) input a second time. Doing so will toggle the **record outputs** on and off. The display will alternatively read the name of the chosen input and **RECD OFF** as shown below.



Defeating the **record outputs** eliminates even the possibility that the input impedance of a recording device could have an effect on the sound quality of the preamplifier. We recommend that **record outputs** be turned **OFF** when not in use.

the balance mode

The **balance** mode gives you extremely fine control over the relative volumes of the Left and Right channels, by changing the volume of one relative to the other in increments of 0.1 dB, up to 20.0 dB. (Beyond this point, the **balance** control will mute the output of the reduced channel entirely.) Once set, this inter-channel difference in volume remains the same regardless of output level and selected input, until it is changed again in the **balance** mode, or when AC power is interrupted (in which case the balance is reset to 0.0).

To enter the **balance** mode from the **monitor** mode, press the **mode** button twice (once from the **record select** mode). When the balance is set to a neutral position, favoring neither channel over the other, the display will show a double-headed arrow and “0.0” decibels—that is, that the channels are balanced with respect to one another.

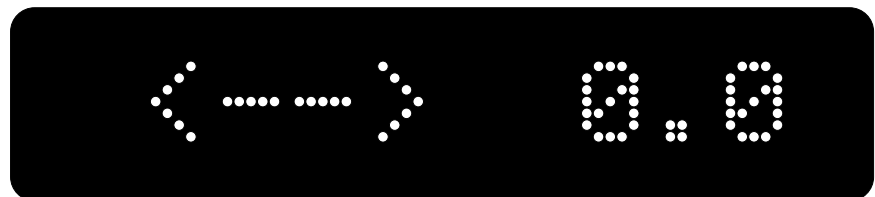

Turning the **knob** (which serves as a balance control in **balance** mode) in either direction will change the balance in that direction. The display will reflect this by changing to the appropriate single-headed arrow to indicate the direction of change and by showing the number of decibels by which that channel has been increased (in tenths of a decibel), as below:

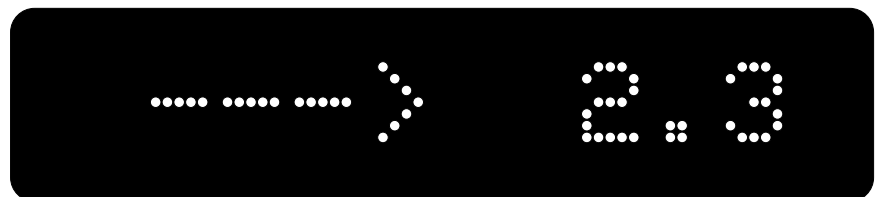

In this example, the right channel is 2.3 decibels louder than the Left.

balance control tip

Precise **balance** control is essential for obtaining accurate soundstaging. Output imbalances due to asymmetrical placement of the loudspeakers in the room are common, and degrade imaging accuracy.

To correct this problem, place the N°380S in **mono** mode and center the resulting image (which should be quite small) directly between the loudspeakers, using the **balance** control. Differences as small as 0.1 or 0.2 decibels have been found to be significant. Try it.

Note that this “mono trick” can correct only for differences that occur *after* the preamplifier in the signal chain, things like asymmetrical placement of loudspeakers or slight mismatches in sensitivity between speakers. If a particular recording is out of balance, you will have to adjust the balance more subjectively, as always.

Using Surround Sound Processors

The N°380S Preamplifier incorporates a special surround sound processor mode which makes it uniquely capable of integrating the highest performance audio with surround sound—that is, dual-purpose music and movie systems. In order to better understand the value of this design, it is essential to understand a bit about the nature of a surround sound processor.

One obvious and fundamental difference between stereo listening and multi-channel listening is the number of channels that must be controlled. When listening to two-channel stereo, one must have a two channel volume control so both speakers increase or decrease in volume in concert with one another. Similarly, when listening to six- or eight-channel surround sound recordings (whether movies or music), one must have a corresponding six- or eight-channel volume control.

This simple fact has made combining a high quality two-channel preamp with an outboard surround sound processor extremely difficult over the years. In fact, until the Mark Levinson N°38 was introduced in 1993, it was virtually impossible to combine the two and have the system work reliably well.

the SSP must not come after the preamp

Dolby Pro Logic decoders incorporate a form of Dolby noise reduction similar to the Dolby B one finds in cassette decks. This form of noise reduction is level-sensitive. That is, Dolby noise reduction intentionally treats strong signals differently than weak signals. In order to operate correctly, the signal strength of the source must be “calibrated” to the expectations of the Dolby noise reduction circuitry. (It is for this reason that one finds “Record Calibration” features on better-quality cassette decks.) ***It is therefore inappropriate to feed a surround sound decoder with the variable output of a preamplifier.*** Were you to do so, every change of the volume control on the preamplifier would cause the Dolby circuitry to mistrack. In extreme cases, severe distortion can result as the Dolby circuitry overloads.

the SSP must not come before the preamp

The next logical alternative might be to use the Pro-Logic decoder *ahead* of the preamplifier, sending its Left and Right outputs through the preamplifier as a selectable Source. ***Sending the Right and Left Outputs from a surround sound decoder to a pair of inputs on a conventional preamplifier is also inappropriate***, since any change of the preamp’s volume control would then throw the carefully calibrated output levels of the decoder out of adjustment, changing the volume of the Left and Right speakers while leaving the Center and Surround speakers unaffected.

One could attempt to restore the proper balance by marking a “calibrated” point on the preamplifier’s volume control and then using only the Pro-Logic decoder to adjust the volume of the system, but this method is both crude and imprecise, yielding inconsistent performance at best.

the SSP must not be in a tape loop

The last remaining alternative would seem to be to insert the decoder “within” a preamplifier by hooking it up in a tape loop. Unfortunately, this setup returns the Left and Right outputs of the decoder to the preamplifier, where they can be inappropriately changed without changing the Center and Surround outputs. ***It is therefore inappropriate to place surround sound decoders in a tape loop.***

It would seem that there is no way to properly integrate a surround sound processor with a preamplifier for a high quality, dual-purpose system.

the SSP & the N°380S

The N°380S solves this dilemma by virtue of a specially-designed surround sound processor interface. When you select the **ssp** name for a particular input on the N°380S, the output level and balance controls are defeated and the preamplifier operates in a “unity gain” mode, passing through whatever signal enters that input without changing its volume in any way. In fact, the display indicates that a line-level signal is being “passed through” unchanged by showing “**LINE**” in the display.



Thanks to this design innovation, ***it is possible for the first time to correctly integrate a surround sound processor with a preamplifier***, sending the processor’s Left and Right outputs through the N°380S (and on to the power amplifier for the main front speakers). Since the output level of these channels cannot be changed by the N°380S while in “ssp” mode, the preamplifier cannot corrupt the careful calibration of the processor’s output levels. And since the audio portion of audio/video sources are fed directly to the processor’s audio input(s) at a line level, input calibration cannot be disturbed by the preamplifier.

Note:

the N°380S will not allow an input with an “ssp” name to be selected during initialization, since allowing a line level signal to pass through unattenuated at start-up presents a potential hazard to your loudspeakers.

wiring diagram using an SSP

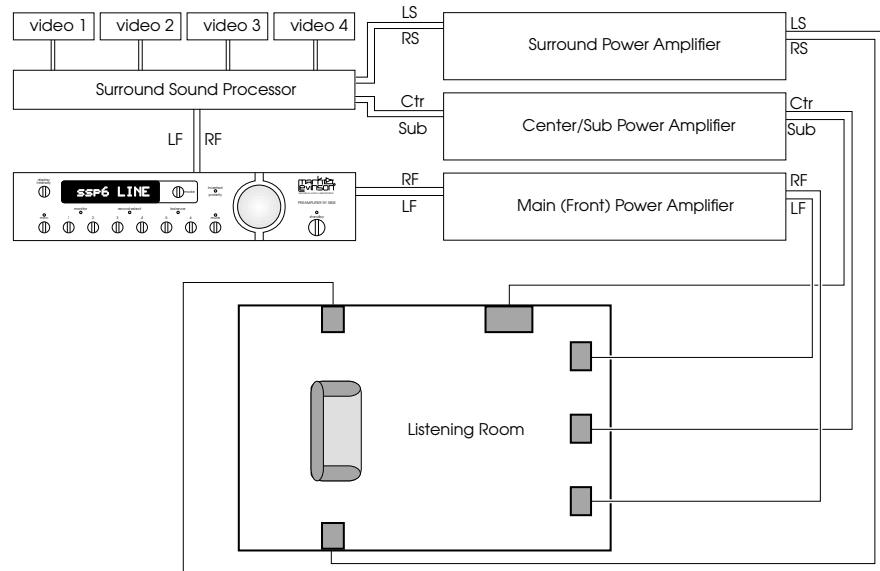

noise in a/v systems

In some cases, connecting your audio and video systems together can result in noise, typically a 50/60 Hz or 100/120 Hz hum. The most common cause for this noise is a "ground loop" caused by the presence of two ground references in the system: one from the power company and another from the cable-television company. The simplest way of solving this problem is to break the cable company's ground by using an isolation transformer on the incoming cable line, before it reaches your television or VCR. If you cannot find a 75Ω-75Ω baluns (isolation) transformer, you can easily construct one from the adaptors which probably came with your VCR and television, as shown below.

Ground Isolation Adaptor

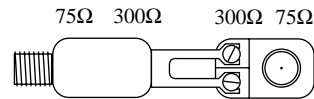

place in-line with your cable feed, prior to the system connection

The assembly shown above may cause some loss of video signal strength and/or bandwidth, and should be used as a temporary fix. It is useful in determining the cause of some video-related noise problems, however, and costs only a few dollars. If it seems to correct a problem, consult with your dealer regarding a long-term solution which does not degrade video performance.

Linked Functions

The N°380S has the ability to “link” several of its functions to certain compatible Mark Levinson components (such as the N°30.5 or N°36S digital processors and the N°31.5 and N°37 CD transport).

Note:

To take advantage of linked functions, you must connect the N°380S to the other, compatible Mark Levinson components via their communication ports. (See “Rear Panel” and “Setup and Installation.”)

There are four linked functions in the N°380S:

display intensity

Adjusting the **display intensity** on any Linked component will adjust the displays in the other Linked components as well, keeping them all at a consistent brightness level.

standby link

Placing the N°380S into **standby** will also place the compatible Mark Levinson digital processor and transport into **standby**, except during a digital recording session (see **record link** section, below). Placing either digital component into **standby** will have no effect on the N°380S, since you might well wish to continue listening to a different source component such as a tuner.

Taking a Linked Mark Levinson source component out of Standby will also cause the N°380S to come out of Standby (and select the appropriate input—see **play link**, below).

play link

Placing your Mark Levinson transport in **play** will activate both the corresponding Mark Levinson digital processor and the N°380S if either or both is in standby. In addition, the appropriate inputs will be selected on the digital processor and on the N°380S (specifically, the input which has an name of a Mark Levinson source component such as N°30, No36 or No39).

Similarly, activating a Linked Mark Levinson digital processor will select the appropriate input on the N°380S (should you be using the processor with an unlinked DAT machine, for example).

record link

Placing the N°380S into **standby** while your Mark Levinson digital audio processor is in **record** mode and a Mark Levinson transport is in Record Link mode will cause a warning to be displayed on the digital component. Both digital components will be prevented from going into **standby** without explicit confirmation at those components that this is what you desire. In this way, inadvertent interruption of a digital recording in process can be avoided.

Care and Maintenance

To remove dust from the cabinet of the N°380S, use a feather duster. To remove dirt and fingerprints, we recommend isopropyl alcohol and a soft cloth. Apply the alcohol to the cloth first and then lightly clean the surface of the N°380S, going with the grain of the brushed aluminum.

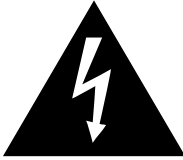

Warning!

At no time should liquid cleaners be applied directly to the N°380S, as direct application of liquids may result in damage to electronic components within the unit.

U.S. and Canadian Warranty

90-day limited warranty

This Mark Levinson® product is warranted to be free from defects in material and workmanship under normal use for a period of ninety (90) days from the date of purchase. **To extend the warranty of this Mark Levinson product**, return the warranty registration card along with a copy of the original receipt of purchase to Madrigal Audio Laboratories, Inc., P. O. Box 781, Middletown, CT 06457.

five year extended warranty

The **extended warranty** for this Mark Levinson product is **five (5) years** from the date of purchase. During the warranty period, any Mark Levinson component exhibiting defects in materials and/or workmanship will be repaired or replaced, at our option, without charge for either parts or labor, at our factory. The warranty will not apply to any Mark Levinson component that has been misused, abused or altered.

Any Mark Levinson component not performing satisfactorily may be returned to the factory for evaluation. Return authorization must first be obtained by either calling or writing the factory prior to shipping the component. The factory will pay for return shipping charges only in the event that the component is found to be defective as above mentioned. There are other stipulations that may apply to shipping charges.

There is no other express warranty on this component. Neither this warranty nor any other warranty, express or implied, including any implied warranties of merchantability or fitness, shall extend beyond the warranty period. No responsibility is assumed for any incidental or consequential damages. Some states do not allow limitations on how long an implied warranty lasts and other states do not allow the exclusion or limitation of incidental or consequential damages, so that the above limitation or exclusion may not apply to you.

This warranty gives you specific legal rights, and you may also have other rights which vary from state to state. **This warranty is applicable in the United States and Canada only.** Outside of the U.S. and Canada, please contact your local, authorized Mark Levinson distributor for warranty and service information.

Obtaining Service

We take great pride in our dealers. Experience, dedication, and integrity make these professionals ideally suited to assist with our customers' service needs.

If your Mark Levinson component must be serviced, please contact your dealer. Your dealer will then decide whether the problem can be remedied locally, or whether to contact Madrigal for further service information or parts, or to obtain a Return Authorization. The Madrigal Technical Services Department works closely with your dealer to solve your service needs expediently.



Important!

Return authorization must be obtained from Madrigal's Technical Services Department BEFORE a unit is shipped for service.

It is extremely important that information about a problem be explicit and complete. A specific, comprehensive description of the problem helps your dealer and the Madrigal Technical Services Department locate and repair the difficulty as quickly as possible.

A copy of the original bill of sale will serve to verify warranty status. Please include it with the unit when it is brought in for warranty service.



Warning!

All returned units must be properly packaged (preferably in their original packing material), and the proper return authorization numbers must be marked on the outer carton for identification. If the packaging to protect the unit is, in our opinion or that of our dealer, inadequate to protect the unit, we reserve the right to repackage it for return shipment at the owner's expense. Neither Madrigal nor your dealer can be responsible for shipping damage due to improper (that is, non-original) packaging.

Your dealer can order a new set of shipping materials for you if you need to ship your component and no longer have the original materials. There will be a charge for this service. We *strongly* recommend saving all packing materials in case you need to ship your unit some day.

Specifications

The correlation between published specifications and sonic quality is unreliable. A list of numbers reveals virtually nothing. All technical measurements must be subject to qualitative as well as quantitative interpretation.

Measurements of the N°380S yield excellent results by any standards. However, only those specifications that apply to its actual operation are included here.

- **Power consumption:** 40W maximum
- **Mains voltage:** 100V, 120V, 200V, 220V, or 240VAC @ 50/60Hz
- **Overall dimensions:** See "Dimensions"
- **Shipping weight:** 35 lbs. (16 kg)
- **Inputs:**
 - 2 stereo balanced (Swiss XLR female)
 - 4 stereo single-ended (Madrigal RCA female)
 - 1 Mark Levinson Link communications connector
 - 1 1/8" mini-jack for external IR repeater
- **Outputs:**
 - 2 stereo record outputs (Madrigal RCA female)
 - 1 stereo balanced main out (Swiss XLR male)
 - 1 stereo single-ended main out (Madrigal RCA female)
 - 1 Mark Levinson Link communications connector
- **Gain:**
- **Gain range:** -72.1 dB to +18.9 dB
- **Gain resolution:** 0.1 dB steps above 38.8 in display (-34 dB), gradually increasing step size at lower levels
- **Input overload:** greater than 16V (0 dB output)
- **Input impedance:** 100k Ω shunted by 220pF
- **Output impedance:** less than 6 Ω
- **Maximum output (MAIN outputs):** 16V rms, balanced

For more information, see your Mark Levinson dealer, or contact:

Madrigal Audio Laboratories, Inc.

P. O. Box 781
2081 South Main Street
Middletown, Connecticut 06457 USA
Phone (860) 346-0896
FAX (860) 346-1540
WWW <http://www.madrigal.com>

Dimensions

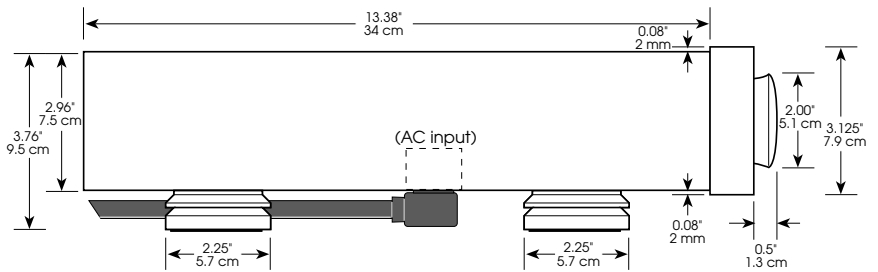
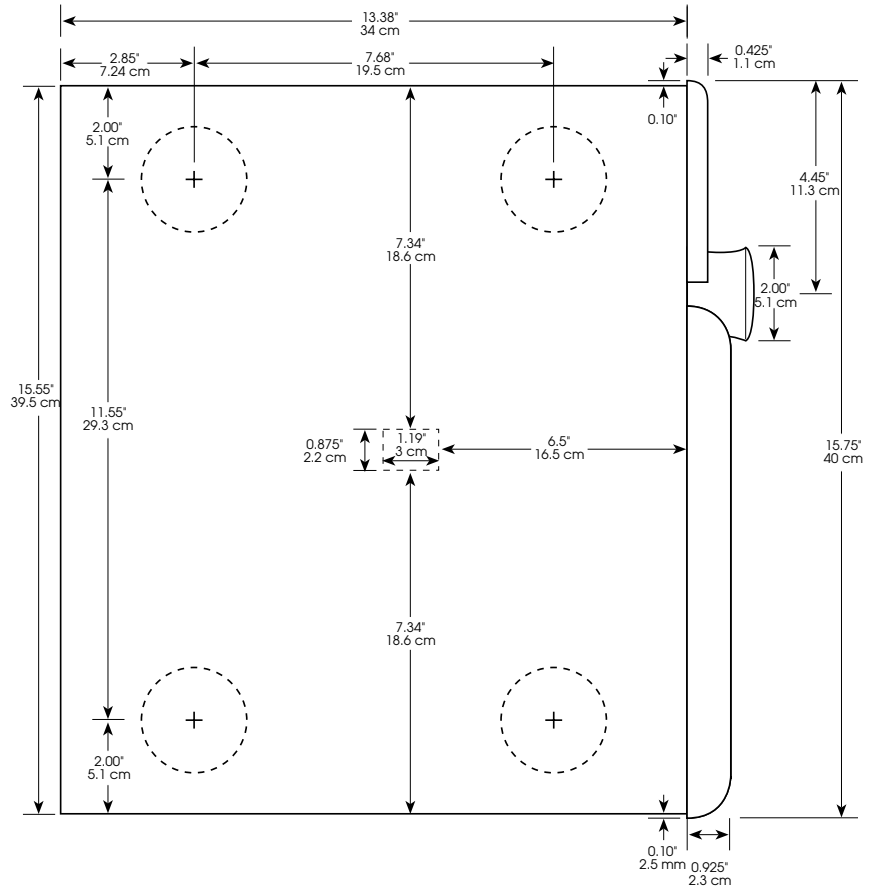



MADRIGAL

Madrigal Audio Laboratories, Inc.
2081 South Main Street, P.O. Box 781
Middletown, Connecticut 06457 USA

Telephone: (860) 346-0896
Fax: (860) 346-1540
<http://www.madrigal.com/>

**mark
levinson[®]**
MADRIGAL AUDIO LABORATORIES

is a registered trademark of Madrigal Audio Laboratories, Inc.
H a Harman International company