

Operating Manual

Mark Levinson®
N°31.5
Reference
CD Transport

Madrigal Audio Laboratories, Inc.

WARNING: TO REDUCE THE RISK OF FIRE OR ELECTRIC SHOCK, DO NOT EXPOSE THIS APPLIANCE TO RAIN OR MOISTURE.

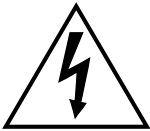
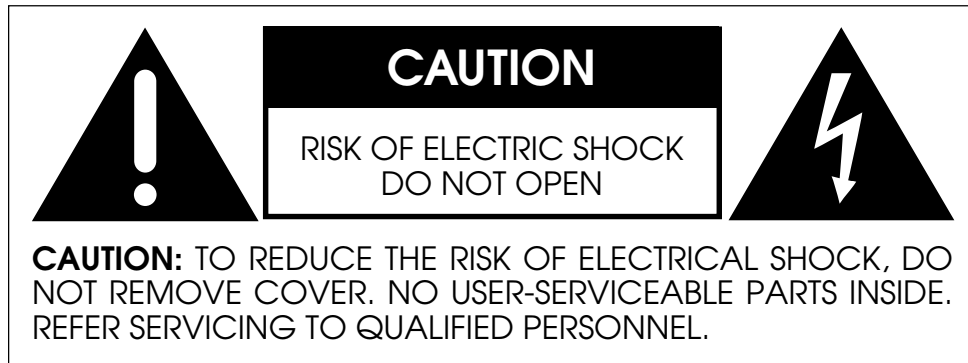

The lightning flash with arrowhead symbol, within an equilateral triangle, is intended to alert the user to the presence of uninsulated “dangerous voltage” within the product’s enclosure that may be of sufficient magnitude to constitute a risk of electric shock to persons.



The exclamation point within an equilateral triangle is intended to alert the user to the presence of important operating and maintenance (servicing) instructions in the literature accompanying the appliance.



Marking by the “CE” symbol (shown left) indicates compliance of this device with the EMC (Electromagnetic Compatibility) and LVD (Low Voltage Directive) standards of the European Community.

NOTICE

This equipment has been tested and found to comply with the limits for a Class B digital device, pursuant to Part 15 of the FCC Rules. These limits are designed to provide reasonable protection against harmful interference in a residential installation. This equipment generates, uses and can radiate radio frequency energy and, if not installed and used in accordance with the instructions, may cause harmful interference to radio communications. However, there is no guarantee that interference will not occur in a particular installation. If this equipment does cause interference to radio or television reception, which can be determined by turning the equipment on and off, the user is encouraged to try to correct the interference by one or more of the following measures:

- Reorient or relocate the receiving antenna;
- Increase the separation between the equipment and the receiver;
- Connect the equipment into an outlet on a circuit different from that to which the receiver is connected;
- Consult the dealer or an experienced radio/TV technician for help.

CAUTION: Changes or modifications to this equipment not expressly approved by the manufacturer could void the user’s authority to operate the equipment.

The information contained in the manual is subject to change without notice. The most current version of this manual will be posted on our web site at <http://www.madrigal.com>.

Important Safety Instructions

Please read all instructions and precautions carefully and completely before operating your Mark Levinson component.

1. **ALWAYS** disconnect your entire system from the AC mains before connecting or disconnecting any cables, or when cleaning any component.
2. This product is equipped with a three-conductor AC mains power cord which includes an earth ground connection. To prevent shock hazard, all three connections must **ALWAYS** be used. If your electrical outlets will not accept this type of plug, an adapter may be purchased. If an adapter is necessary, be sure it is an approved type and is used properly, supplying an earth ground. If you are not sure of the integrity of your home electrical system, contact a licensed electrician for assistance.
3. **ALWAYS** keep electrical equipment out of the reach of children.
4. AC extension cords are not recommended for use with this product. If an extension cord must be used, be sure it is an approved type and has sufficient current-carrying capacity to power this product.
5. **NEVER** use flammable or combustible chemicals for cleaning audio components.
6. **NEVER** operate this product with any covers removed.
7. **NEVER** wet the inside of this product with any liquid.
8. **NEVER** pour or spill liquids directly onto this unit.
9. **NEVER** block air flow through ventilation slots or heatsinks.
10. **NEVER** bypass any fuse.
11. **NEVER** replace any fuse with a value or type other than those specified.
12. **NEVER** attempt to repair this product. If a problem occurs, contact your Mark Levinson® dealer.
13. **NEVER** expose this product to extremely high or low temperatures.
14. **NEVER** operate this product in an explosive atmosphere.
15. **ALWAYS** unplug sensitive electronic equipment during lightning storms.

Table of Contents

Unpacking and Placement	6
Unpacking the N°31.5	6
Remove the Transport Screws	6
Placement of the N°31.5	6
Operating Voltage & Frequency	7
<i>Voltage label</i>	7
A Quick Start.....	8
Warm up/break-in period	9
Special Design Features.....	10
A New Generation	10
Digital Servo Control	10
Output Versatility	10
Industrial Design	11
Convenience Features	11
Communications Links	11
Setup and Installation.....	12
Front Panel.....	17
Top Panel	21
CD Transport Assembly	24
The Disc Damper	25
Removing the Disc Damper	25
Display	26
Display messages	27
Remote Control	28
Random Play	29
Analog Input Switching	30
Direct access to inputs	31
Conditions that Affect IR Performance	32
<i>Optimum IR reception window</i>	33
Rear Panel	34
Basic Operation	37
Loading a CD	37
Temporarily overriding a previously saved program	37
Playing all tracks in order	37
Beginning play with other than the first track	37
Replaying a track	37
Random play	38
Skipping to another track	38
Searching for a passage	38
Previewing a CD	38
Using indices	39
Beginning play at a specific location in a track	39
The pause function	39
Repeating an entire CD	39
Repeating a track	39
Repeating a specific passage	40
Inverting playback polarity	40
Stopping play	40

Introduction to Programming	41
How the N°31.5 remembers programs	41
Assembling a new program	41
Delete Programming	42
Advanced Programming	43
Reviewing a program	43
Adding a selection	43
Erasing a selection	44
Temporarily overriding a previously saved program	44
Erasing a program	44
Setting Options	45
Auto-Standby	47
Madrigal Communications Link	48
Understanding the Architecture	48
“Linked amplifiers?” you ask	49
Which Cables Go Where?	50
Using the latest software	51
Using Learning Remote Controls	52
Teaching N°31.5 Front Panel Commands	52
Teaching Other N°31.5 Commands	53
<i>special commands table</i>	54
Troubleshooting	55
Care and Maintenance	57
U.S. and Canadian Warranty	58
Limited five year warranty	58
Obtaining Service	59
Specifications	60
Dimensions	61

Unpacking and Placement

Unpacking the N°31.5

Unpack your N°31.5 Reference CD Transport and remove all accessories from the carton. Included with your new Mark Levinson transport is a pair of knit, white gloves designed to assist you in the initial unpacking and placement of your new purchase. Please accept them as a token of our appreciation for having purchased one of our products.



Important!

Keep all packing materials for future transport of your N°31.5. Shipping your new component in anything other than its purpose-designed packing material may result in damage that is not covered by the warranty.

Remove the Transport Screws

Protecting the finish by placing it on a soft cloth, prop up the N°31.5 Reference CD Transport on its side to provide ready access to the bottom of the center section. Remove the transport screws from the bottom of the unit, along with the shipping strap that holds the lid closed during transport. (**Note that it is normal for the N°31.5 lid to “float” open before power is supplied to the unit.**) Save them with all the other packing materials for future use.

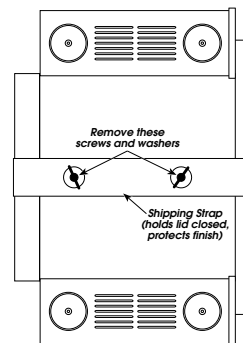

Warning!

The transport screws and shipping strap must be removed before operating the N°31.5, since they immobilize the transport mechanism and lid during shipping to prevent damage. This strap and these screws must also be replaced before shipping the unit.

Placement of the N°31.5

The N°31.5 should be placed as close as possible to your digital audio processor, thus keeping digital interconnect cabling reasonably short. It should be placed on a shelf where it is convenient to operate and receives good ventilation.

Be sure to allow 7 inches (18 cm) of clearance above the N°31.5 to ensure proper operation of the lid assembly. The N°31.5 must also be within 3° of level from front to back for optimal operation of the lid. (*This translates to having the front and back edges of the N°31.5 within about 1/2" or 1.2 cm of level with each other.*) Drawings are included in this manual to facilitate special installations and custom cabinetry (see *Dimensions*).

Operating Voltage & Frequency

The N°31.5 Reference CD Transport is set at the factory (internally) for 100V, 120V, 200V, 220V, or 240V AC mains operation as appropriate for the country in which it is to be sold. (*230V/50Hz only in European Union countries, in compliance with CE regulations.*) Make sure that the label on the rear of the right tower of the N°31.5 (adjacent to the power cord) indicates the correct AC operating voltage for your location, as attempting to operate the N°31.5 at an incorrect voltage can damage the unit.

The N°31.5 Reference CD Transport is also set at the factory for operation on either 50 or 60 Hz AC line frequencies, as appropriate for the country in which it is to be sold. It will not operate if it senses an incorrect line frequency.

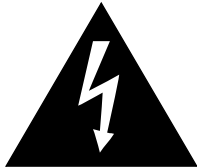

Warning!

Neither the voltage nor the line frequency setting may be changed by the user. There are no user serviceable parts inside the N°31.5. Only qualified, authorized service personnel may open the N°31.5 Reference CD Transport, as hazardous voltages exist within the unit.

If the AC mains voltage or frequency indicated on your N°31.5 is incorrect, please contact your local, authorized Mark Levinson dealer or distributor.

The N°31.5 can easily be powered by a normal 15-ampere AC mains line. If other devices are also powered from the same AC line, their additional power consumption should be taken into account.

A Quick Start...

We recognize that many people are understandably eager to begin listening to their new components, and that reading the manual is often done (if at all) at a later time—perhaps while listening to music with the new product itself. We *strongly* recommend that you read this manual thoroughly, as the N°31.5 Reference CD Transport incorporates many unusual features that enhance its operation.

Fortunately, we can help you get some music up and running on your system quickly, so that you may begin enjoying your new CD transport while reading more about it. The goal here is simply to make some music as quickly as possible. The following procedure assumes that the rest of your system is already connected (e.g., digital processor to preamplifier, to power amplifier, to speakers, etc.).

1 TURN OFF YOUR ASSOCIATED COMPONENTS

This minimizes the opportunity for a momentary electrical surge disturbing your system while making connections. If you have a large power amplifier, allow its power supply to fully discharge before proceeding (which may take as long as several minutes, depending on its design).

2 REMOVE THE TRANSPORT SCREWS FROM THE BOTTOM OF THE N°31.5

If you have not done so already, remove the transport screws from the bottom of the N°31.5 now, as per the directions on page 13. Be sure to save them and all packing material for possible future use. (*Shipping the N°31.5 without proper packing material and without the transport screws in their proper positions may cause damage to the unit that would not be covered by the warranty.*)

3 CONNECT THE N°31.5 TO AC POWER

Connect the AC cord to the N°31.5 at the receptacle on the rear panel (right tower as seen from the front), and then to your AC outlet. Then turn on the power switch just above the AC power receptacle. (The international symbol for “on” is a single vertical line: |. “Off” is symbolized by a circle: O.) The N°31.5 will take a few moments to initialize and will then be ready to use.

4 CONNECT A DIGITAL OUTPUT TO A MATCHING DIGITAL INPUT ON YOUR PROCESSOR

The N°31.5 supports a variety of types of digital outputs to ensure compatibility with any digital processor you might wish to use. These digital outputs are found on the rear of the N°31.5. In our experience, *when fully optimized at both ends*, the AES/EBU professional digital interconnection standard is the finest available. Depending on your processor, however, you may find that a different interface is best in your system. It is important to use high quality digital cable such as Madrigal MDC-1 for AES/EBU (via XLRs), or MDC-2 for S/PDIF (via RCA) connections.

5 POWER UP THE REST OF THE SYSTEM, LEAVING THE POWER AMPLIFIERS FOR LAST

Always turn the power amplifier(s) off first, and on last. This good habit minimizes the opportunity for unexpected transients reaching your loudspeakers.

6 SELECT THE INPUTS YOU ARE USING ON YOUR DIGITAL PROCESSOR AND PREAMPLIFIER

Take care that a Tape Monitor switch does not override your selection of the digital processor's input on your preamplifier, or you will be struck by how "quiet" your new digital source is...

7 LOAD A DISC AND PRESS PLAY; SLOWLY RAISE THE VOLUME ON YOUR PREAMPLIFIER

Congratulations! You should now be able to enjoy your favorite music while reading the rest of this manual. (Please, do read the rest of this manual.)

Warm up/break-in period

Although your Mark Levinson N°31.5 Reference CD Transport delivers outstanding performance straight out of the box, you should expect to hear it continue to improve as it reaches its normal operating temperatures and its various components "break-in." For example, the pulse transformers* will not reach their ultimate performance until they have been driven with an actual load (meaning the digital output must be connected to something) for about 24 hours.

It has been our experience that the greatest changes occur within the first few hours as the N°31.5 reaches thermal equilibrium. Depending on how cold the N°31.5 was when you first connected it to AC power, full thermal equilibrium might take as long as a day or two, after which time its performance will remain quite constant.

The only exception to this rule is if power is removed from the unit for more than a few minutes, allowing it to cool down. Depending on the degree of cooling involved, you should expect a brief warm-up period before the N°31.5's sound quality is at its best. Unless your N°31.5 was allowed to become quite chilled, subsequent thermal re-stabilization should not take long.

* Pulse transformers couple the internal digital circuitry to the actual connector on the rear panel. The ones used in your N°31.5 are costly and offer extraordinary performance. Even so, they exhibit this modest "break in" period during which they improve beyond their initial performance.

Special Design Features

Congratulations on your purchase of the N°31.5 Reference CD Transport. The Madrigal design team is confident you will enjoy the outstanding performance of the N°31.5 for many years. In case you are interested in technical details, what follows is a brief outline of some of the key technologies in your new transport.

A New Generation

The characteristics of an outstanding CD transport are simple to define: it must recover the correct data from the disc, and deliver it to the digital processor without any timing errors (sometimes called “jitter”). As simple as this sounds, achieving it in reality has been extremely difficult—as evidenced by the significant sonic differences between various CD transports.

Conventional CD transport design depends on the quality of the oscillator used to control the rate at which the disc itself spins. This oscillator exists in an extremely “noisy” electrical environment close to the motor that spins the disc. The electrical noise introduces timing errors in the delivery of the digital signal that have come to be known as “jitter.” Subsequent handling of the digital audio signal in traditional transport designs cannot improve upon this “jittery” signal, lacking a better reference. To the contrary, the various stages of signal processing between the laser pickup and the final output can only contribute additional jitter of their own.

The Mark Levinson N°31.5 leaps beyond conventional digital audio technology by employing a proprietary, closed-loop jitter-reduction system in conjunction with a double speed CD-ROM drive. Using a custom-made, mechanically and electrically isolated crystal oscillator as a reference, the digital signal is relocked immediately before the output, eliminating transport-related jitter from the digital audio signal. This same five part-per-million crystal oscillator controls the all-digital servo used to control the rate at which the disc spins.

In effect, the design of the N°31.5 turns the accepted *status quo* on its head. By placing the all-important reference clock in the *final* stage of the transport’s output section, and slaving the mechanical subassemblies to it rather than the other way around, the signal presented to the outputs of the N°31.5 is uncontaminated by electrically- or mechanically-induced jitter. The sonic advantages of this design are immediately apparent in the clarity, warmth and stunning dynamic contrasts exhibited by the N°31.5.

Digital Servo Control

The laser mechanism used in the N°31.5 uses all an digital servo control. Critical functions such as focus and tracking are handled completely in the digital domain, with mathematical precision. Whereas conventional, analog servos may require periodic realignment for optimum performance (to compensate for the aging of various analog components), a digital servo remains stable over time, never needing readjustment under normal conditions.

Output Versatility

The N°31.5 supports a wide variety of digital output configurations to ensure optimal performance with a wide range of digital audio processors. A new complementary driver for the balanced AES/EBU electrical output delivers outstanding performance to the high quality XLR connector. Single-ended S/PDIF electrical output is provided *via* an RCA connector, and the ST optical output uses a high-

bandwidth Hewlett Packard® part for superior performance. A high quality EIAJ optical interface has also been included for maximum compatibility, although in our experience it should be the interface of last resort. (It offers the least potential for high performance of any of the standard digital interfaces.)

All digital interfaces have been carefully optimized to deliver the finest performance each interface standard allows. As a direct result, the N°31.5 performs optimally with any digital processor, without having to resort to techniques which would limit its compatibility to other Mark Levinson products.

Industrial Design

The N°31.5 shares the striking industrial design of other Mark Levinson components such as the N°30.5 digital audio processor. The combination of the hand-brushed, black-anodized aluminum faceplate and bead-blasted custom-machined buttons make operating the N°31.5 a tactile as well as a sonic pleasure.

A large, easily read display provides information as to the operational status of the N°31.5 from across the room, making the supplied remote control more genuinely useful than on products lacking such a display.

Convenience Features

Too often, high performance CD transports have eschewed convenience in the hopes of seeming more “performance-oriented.” While there were good arguments for such a “minimalist” design in the days of analog turntables, the time is long gone when the audiophile needed to give up operational convenience for musical performance. After all, convenience features in a digital product are largely a matter of writing appropriate software, and have no affect on the quality of the digital data itself.

For example, the N°31.5 supports custom programs, including “delete programming” wherein selected tracks are omitted from the playlist. This allows the user to skip the one or two songs on an otherwise good disc that have been overplayed *ad nauseam*. The N°31.5 will remember such programs for thousands of discs, should you want to save that many programs.

Communications Links

As with all Mark Levinson 30-series components, the N°31.5 incorporates a sophisticated inter-component communications bus. Unique among high performance audio systems, Mark Levinson 30-series components offer a degree of system integration that makes even complex systems easy to use.

For example, bringing the N°31.5 Reference CD Transport out of standby will also bring the Linked digital audio processor, preamplifier and power amplifier(s) out of standby, and select the appropriate inputs on both processor and preamplifier so that a CD can be enjoyed. Even a sophisticated system with many components can thus offer one-button simplicity of operation.

In short, the Mark Levinson N°31.5 establishes a new standard for performance and practicality among high end CD transports and should be auditioned by anyone who desires the finest in digital audio.

Setup and Installation

For your protection, review Important Safety Instructions before you install your N°31.5.

Carefully open the shipping carton and remove the contents. You should have:

- Mark Levinson N°31.5 Reference Digital Transport
- Remote control
- Two AA batteries
- Disc damper
- Four spikes
- AC power cord
- Link cable (2m)
- Two spare 1.0-ampere slow-blow fuses
- One 5/64" hex key (for remote control)
- One 1/8" hex key (for feet/spikes)
- One 3/32" hex driver (for levelling the transport)
- Owner's manual

Save the shipping carton and all packing material. Though it may be inconvenient to store, it will come in handy for shipping if you move, or if the N°31.5 needs to be shipped for service. If you need to ship your N°31.5 and have lost the original packing materials, please contact your local dealer or distributor for the purpose-designed, exact replacements rather than trying to fabricate something.



Warning:

Shipping the N°31.5 in anything other than its purpose-designed shipping materials may result in damage that would not be covered under any warranty.

In addition to the tools we provide, you will need the following to set up your N°31.5:

- A soft cloth or towel
- A digital-audio cable

1 INSTALL THE SPIKES INTO THE FEET (OPTIONAL)

The N°31.5 is shipped so that it rests solidly on its four rubber-covered feet, one under each corner of the unit. You may want to explore the potential sonic advantages of installing the specially designed “spikes” supplied with the N°31.5. *These spikes are quite sharp and may damage furniture.* We do not recommend their use unless your N°31.5 will rest on thick tempered glass, or something equivalently resistant to scratches.

If you decide to experiment with these spikes, make sure that the N°31.5 is unplugged from the AC power supply and disconnected from your digital processor. Then place the N°31.5 upright on a flat, stable surface. Protecting its finish with a soft cloth, carefully tip it so it rests ***on its side***, not its top.

Install the spikes one at a time. Using the supplied 1/8" hex key, remove the screw securing the foot to the N°31.5's chassis. Insert the threaded end of the spike through the hole in the foot into the threaded hole in the chassis, then turn the spike clockwise until it is finger-tight. (Be careful not to overtighten it.)

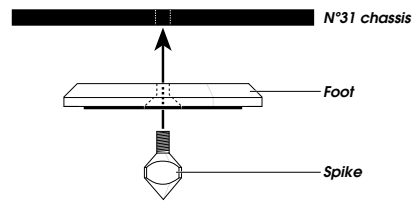

Repeat this procedure for the other three spikes.

2 REMOVE THE TRANSPORT SCREWS *** REQUIRED! ***

If you have not already placed the N°31.5 on its side on top of a soft cloth (as described in the previous step), please do so now. (See warning above.)

Locate the two transport screws on the bottom of the N°31.5, and remove them by turning them counterclockwise (no tools are necessary). When finished, return the N°31.5 to its normal, upright position.

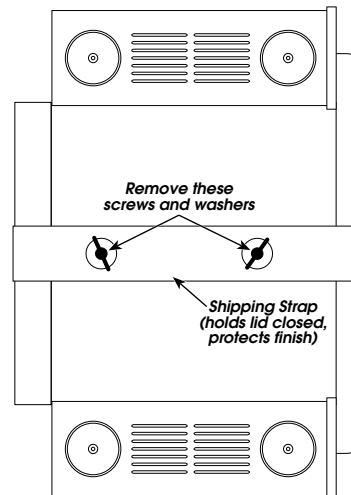

Important:

Save the transport screws, washers, and shipping strap with the packing material. If you ever need to ship the N°31.5, you must replace them.

Replacing the transport screws is easiest when the N°31.5 is level and upright, with its feet supported on raised blocks and the transport screws inserted from underneath.

3 CONNECT THE N°31.5 TO THE AC MAINS

Insert the supplied shielded AC cord into the IEC-standard AC socket on the rear panel of the N°31.5. Check to ensure that the power switch is in the “Off” (○) position. Double-check the voltage label on the rear panel of the N°31.5 to ensure that it matches the supplied AC voltage in your country.

If the voltage indicated is incorrect, or if you wish to change the AC operating voltage of the N°31.5, see your Mark Levinson dealer.

Assuming everything matches, plug the other end of the power cord into the AC mains and turn on the power switch (to its I position).

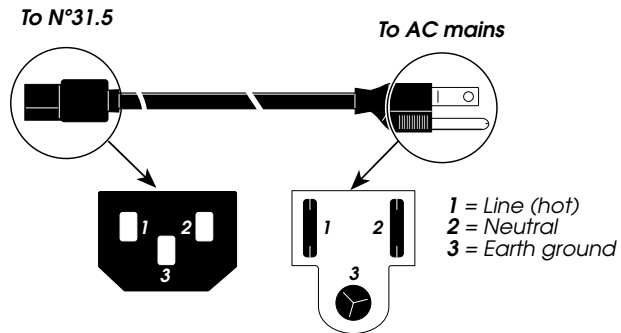

Note: The N°31.5 will not achieve its sonic potential right away — sonic performance is close to the optimum within a day or two of normal use. For the best performance, you may leave the **main power** switch on at all times, except when you won't be using your N°31.5 for a long period. (See *Important Safety Instructions*).

The N°31.5 may be turned on and off without significantly affecting its longevity. When it is turned on after being left turned *off* (as opposed to standby), allow about one hour before expecting optimal sonic performance. (This assumes that it remained at room temperature while off. A chilled transport will take somewhat longer to revive.)

4 CONNECT A DIGITAL OUTPUT TO YOUR PROCESSOR

To keep interconnect cabling as short as possible, place the N°31.5 as close as possible to your digital processor. You may place it on a shelf or in a cabinet where it's convenient to operate.

As a precaution, turn off your other components (especially the power amplifier). Then, using a high quality, purpose-designed digital interconnect, connect an output of the N°31.5 to the corresponding input of your digital processor.

5 IF YOU HAVE A MARK LEVINSON DIGITAL PROCESSOR, CONNECT THE COMMUNICATIONS LINK CABLE

Mark Levinson components employ a sophisticated inter-component communications system that offers many operational advantages and user conveniences not otherwise possible. If you have a Mark Levinson digital audio processor, connect the supplied Link cable from the processor's **master** communications port to the N°31.5's **slave in** port.



Warning:

Connecting the communication ports other than as described in this manual may damage the N°31.5 and/or the digital processor, and will void the products' warranties.

Assuming both the Link connection and the digital interconnection have been made, merely pressing **play** the first time will establish the Link between components.

6 PLACEMENT OF YOUR TRANSPORT

The N°31.5 should rest on a level, stable surface. To ensure smooth operation of the lid, the N°31.5 should be within about 3° of being level from front to back (the front and rear of the unit need to be within about ½" or 1.2cm of being level with each other). Avoid placing it where it will be exposed to shocks or vibration, such as on an unstable table or near large loudspeakers. In general, place it as you would a turntable.

You should also place other associated equipment so that it does not induce hum in the N°31.5 or any other sensitive components.

Caution:

Interfering with the N°31.5's ventilation or that of another component could cause either to overheat, resulting in damage to your system. To allow heat dissipation through air circulation, allow 3 to 4 inches of clearance above the vents on the top of the N°31.5. Never block the vents on the bottom of the N°31.5.

To help with special installations and custom cabinetry, drawings are included in this manual. (See *Dimensions*).

7 LEVELLING YOUR TRANSPORT

For the best performance, the N°31.5's transport assembly should be level.

- Ensuring that the unit itself is approximately level enables the Lid to operate as smoothly as it was designed. This requires only that the unit be within about ½" (or 1.2cm) of being level from front to back—hardly a stringent requirement.
- Levelling the laser/motor mechanism *within* the N°31.5 yields the best sonic performance. Four levelling screws (one inside each finger well) allow you to adjust this easily.

Press the **Lid Open/Close** button on the top panel to open the lid of the N°31.5. With the supplied ⅜" hex driver, and using the N°31.5's bubble level as a gauge, adjust one or more of these screws to bring the transport assembly to level. To lower a corner, turn the corresponding screw clockwise; to raise a corner, turn the screw counterclockwise. (See *diagram on the next page*.)

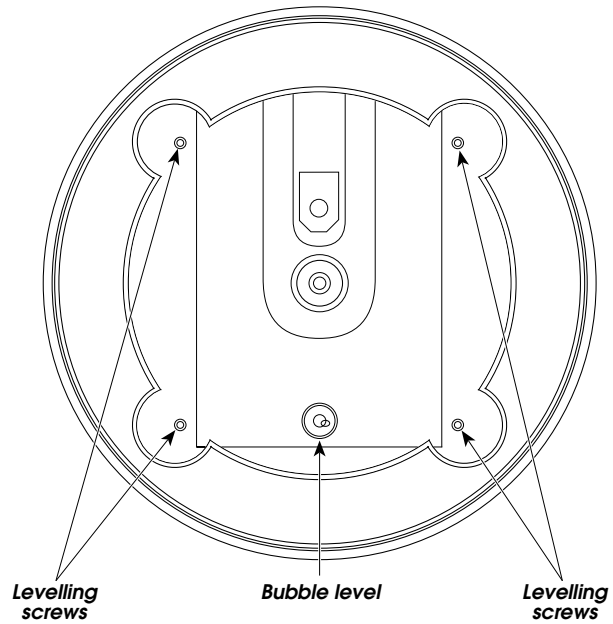

When level, place the disc damper on the spindle, then press Lid Open/Close again to close the Lid.

8 INSERT BATTERIES IN THE REMOTE CONTROL

Using the supplied $\frac{5}{64}$ " hex key, remove the two screws securing the cover of the Remote Control's battery compartment (the end opposite the projection lens).

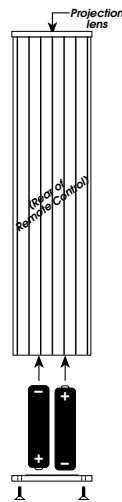

Insert two AA batteries according to the symbols on the inside of the battery compartment cover. Replace the battery compartment cover and screws.

9 TURN EVERYTHING ON, AND ENJOY!

After all connections have been made in the system, turn on the various components, leaving the power amplifier(s) for last.

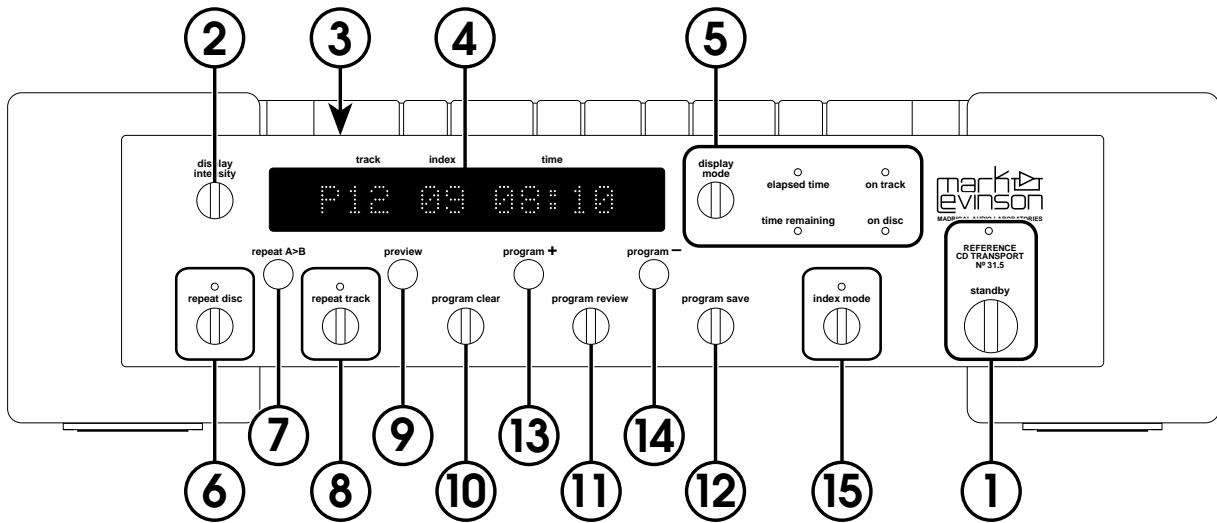

Front Panel

1 STANDBY

When the N°31.5 is connected to AC power and the main power switch on the rear panel is in the “1” position (see *Rear Panel*), pressing this button takes the N°31.5 out of “standby” mode and enables the front-panel controls.

When the N°31.5’s main power switch is first turned on (or when power is restored after an interruption), the N°31.5 will be ready to operate (that is, it won’t be in standby mode).

Pressing **standby** again places the N°31.5 into standby mode and disables the front-panel controls. Pressing the **open lid** button will both switch the unit out of standby and open the lid so you may load a disc.

While the N°31.5 is in standby mode, the display is dark and the **standby LED** flashes slowly. When the N°31.5 is ready to operate (not in standby mode), the **standby LED** remains lighted.

Note:

When going into standby, the N°31.5 deactivates its digital outputs. With some digital processors, this may result in a low-level “pop” on the audio outputs. (Mark Levinson digital processors do not exhibit this problem.)

If your processor generates such a pop, and if you wish to prevent this low-level “pop” from coming through your system’s speakers or headphones, adjust your preamp’s volume to its lowest level before placing the N°31.5 into standby.

2 DISPLAY INTENSITY

Pressing this button varies the brightness of the display. Four brightness levels are available.

When the N°31.5's main power switch is first turned on (or when power is restored after an interruption), the display is automatically set to its second-brightest level.

Pressing **display intensity** once dims the display one level; pressing it again dims it further; pressing it again turns the display off. Pressing **display intensity** once more returns the display to its brightest level.

display intensity also affects the N°31.5's front-panel LEDs. When the display is turned off, however, the LEDs still glow dimly.

3 TOP-PANEL CONTROLS

See *Top Panel*.

4 DISPLAY

See *Display*.

5 DISPLAY MODE

This button allows you to change the type of information shown in the **time** portion of the display. (See *Display*.)

When a CD is loaded and ready for play, the **time** portion of the display shows the time remaining on the CD; the **time remaining** and **on disc** LEDs are lighted.

Press **display mode** to change the **time** part of the display:

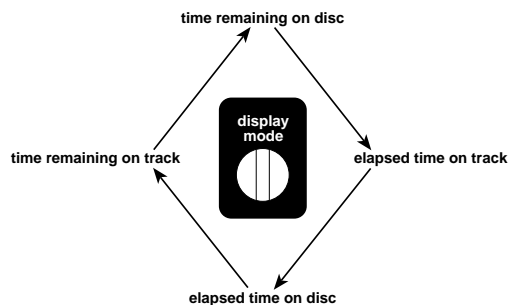

The information in the **time** portion of the display corresponds to the lighted LEDs to the right of the **display mode** button. After play begins, the display will reflect the last display mode you selected.

Along with **program +** (13) and **program -** (14), the **display mode** button is also used to change the link settings. (See *Setting Options*.)

6 REPEAT DISC

To repeat (continuously) all tracks on a CD (or all tracks in a program), press this button. Note that this function and the **repeat track** function are mutually exclusive.

While **repeat disc** is active, the LED above the button is lit.

To return to normal play, press **repeat disc** again.

7 REPEAT A-B

This function allows you to repeat (continuously) a particular phrase or passage on a CD.

While a CD is playing, press **repeat A-B** at the beginning of the passage you would like to repeat. At the end of the passage, press **repeat A-B** again. The passage you selected will repeat continuously. While **repeat A-B** is active, **A** then **B** will alternate appearing in the space preceding the track number on the display.

To return to normal play, press **repeat A-B** again. Alternatively, you may press **stop** to leave the **repeat A-B** mode and enter **stop**. Directly accessing a point *after* the “B” point of your **A-B** loop (via pressing **next track**, **direct time** access, or **direct track** access) will cancel the **repeat A-B** loop and return you to normal **play** mode at your selected point.

8 REPEAT TRACK

To repeat (continuously) the track in play, press this button. Note that this function and the **repeat disc** function are mutually exclusive.

While **repeat track** is active, the LED above the button is lighted.

To return to normal play, press **repeat track** again.

9 PREVIEW

This function allows you to play only the introduction of each track on a CD or in a program.

Once a CD is loaded and ready for play, press **preview**. Beginning with the first track on the CD (or the first track in the program), the N°31.5 will play the first ten seconds of the track, skip to the second track and play the first ten seconds of that track, and so on.

While **preview** is active, the **track** part of the display flashes. (See *Display*.)

To return to normal play, press **preview** again, or press **play**. (See *Top Panel*.)

10 PROGRAM CLEAR

Pressing this button erases any temporary program, and also temporarily overrides a previously saved program. (See *Programming*.) After pressing **program clear**, the display will show **PROG CLEARED**.

Pressing **program clear**, followed by pressing **program save** (12), permanently erases a program from the N°31.5's memory and displays **PROG DELETED** in the main display.

If you press **program clear** when there is no program in the N°31.5's memory, the display will show **NO PROGRAM**.

11 PROGRAM REVIEW

This function allows you to review the selections in the current program. (See *Programming*.)

Press this button once to view the first selection in your program. To view the next selection, press **program review** again, and so on.

After you view the last selection in the program, the display will show **PROGRAM END**.

If you press **program review** when there is no program in the N°31.5's memory, the display will show **NO PROGRAM**.

12 PROGRAM SAVE

Pressing this button records a program in the N°31.5's memory. (See *Programming*.)

After pressing **program save**, the display will show **NEW PROGRAM**, **PROG CHANGED**, or **PROG DELETED** (depending on your previous actions, which are then "saved").

13 PROGRAM +

Pressing this button adds a selection to a program. (See *Programming*.)

Along with **display mode** (5), the **program +** button is used to change the link settings. (See *Setting Options*.)

14 PROGRAM -

Used along with **program review** (11), pressing this button erases a selection from a previously saved program without erasing the entire program. (See *Programming*.)

Along with **display mode** (5), the **program -** button is used to change the link settings. (See *Setting Options*.)

15 INDEX MODE

When you're playing a CD recorded with indices, the N°31.5's index mode allows you to use those indices to select more precisely the music you want to play.

After pressing **index mode** before playing the CD, the display will show **INDEX SEARCH**.

While the index mode function is active, the LED above the button flashes.

While the N°31.5 is in index mode, pressing **next** or **previous** skips the laser pickup to the next or previous index on the CD (see *Top Panel*), and you may use the Remote Control's numbered buttons to select indices (see *Remote Control*).

To cancel this function, press **index mode** again, or press **stop**.

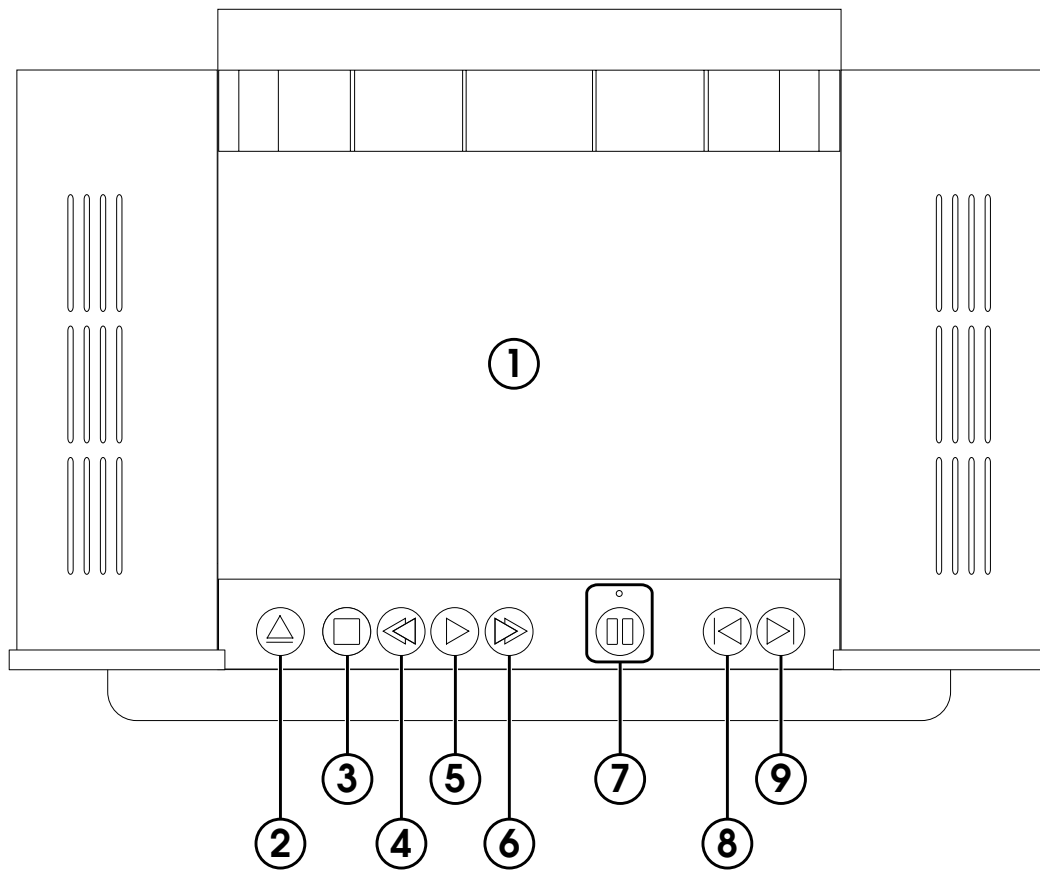

Top Panel

1 LID

The Lid covers the CD transport assembly, the mechanism that holds the CD during play. Its operation is controlled by the **Lid Open/Close** button (2).



2 LID OPEN/CLOSE

Pressing this button opens the Lid (1); pressing it again closes the Lid.

Pressing **Lid Open/Close** while a CD is playing stops play and opens the Lid.



3 STOP

Pressing this button while a CD is playing stops play. Pressing **stop** also cancels **repeat disc** and **repeat track**, if they're active.

Pressing **play** (5) after pressing **stop** begins play again with the first track on the CD (or the first track in a program, if one exists).



4 SEARCH REVERSE

Holding this button down during play moves the laser pickup rapidly toward the beginning of the CD, and provides audible cueing.

☛ If your N°31.5 is connected to a compatible Mark Levinson digital processor (via the communication ports), you may choose to mute the volume completely during search. (See *Setting Options*.)

When you release **search reverse**, play normally resumes. If you have reached the beginning of the disc, the N°31.5 will **stop** at the beginning of the disc (or program, if you are playing one) and wait for your next command.



5 PLAY

After a CD is loaded and the **disc damper** is in place, pressing this button begins play with the first track on the CD (or the first track in a program).

If you press **play** while the Lid is open, the Lid closes and play starts beginning with the first track on the CD (or the first track in a previously saved program). Similarly, pressing **play** while the N°31.5 is in standby will cause the unit to become operational and start playing the first track on the disc or in the program.

Pressing **play** while a CD is playing suspends play, returns to the beginning of the current track, and replays that track.



6 SEARCH FORWARD

This button works in the same way as **Search Reverse** (4), except that it moves the laser pickup rapidly toward the end of the CD.



7 PAUSE

While a CD is playing, pressing this button suspends play; pressing it again resumes play at the point where **pause** was first pressed. While **pause** is active, the LED above the button is lighted and **||** appears preceding the track number on the display. (See *Display*.)

If left in **pause** for several minutes, the transport will stop spinning and the laser will turn off (thereby enhancing the longevity of both). This will be indicated by the **pause** indicator in the display (“||”) flashing on and off.

Alternatively, this **extended pause** feature may be engaged by pressing and holding the **pause** button until the indicator begins to flash in the display. Pressing **pause** again will resume play at the point where **pause** was first pressed, (after a short delay to allow the disc to get up to speed).

To “cue up” the beginning of a CD or track, press **pause** *before* pressing **play** (5). To begin play, press **pause** again. (You may also select another track or index while play is suspended.)



8 PREVIOUS

This button's function depends on whether or not the N°31.5 is in index mode. (See *Front Panel*.)

While the N°31.5 is in index mode, pressing **previous** “skips” the laser pickup to the previous *index*. If index mode is inactive, pressing **previous** skips the laser pickup to the previous *track*.

Pressing **previous** while a CD is playing suspends play, skips the laser pickup to the previous track or index on the CD (or in a program), and begins play there.

☛ *If you press **previous** while the first track on the CD (or in a program) is playing, the display will show **FIRST TRACK**.*

Pressing **previous** before play begins skips the laser pickup to the beginning of the last track or index on the CD; pressing **play** (5) begins play there (temporarily overriding any existing program).



9 NEXT

This button works in the same way as **previous** (8), except that it skips to the *next* track or index.

While the N°31.5 is in index mode, pressing **next** skips the laser pickup to the next *index*. If index mode is inactive, pressing **next** skips the laser pickup to the next *track*.

Pressing **next** while a CD is playing suspends play, skips the laser pickup to the next track or index on the CD (or in a program), and begins play there.

☛ *If you press **next** while the last track on the CD (or in a program) is playing, the display will show **LAST TRACK**.*

Pressing **next** before play begins skips the laser pickup to the beginning of the next track or index on the CD; pressing **play** (5) begins play there (temporarily overriding any existing program).

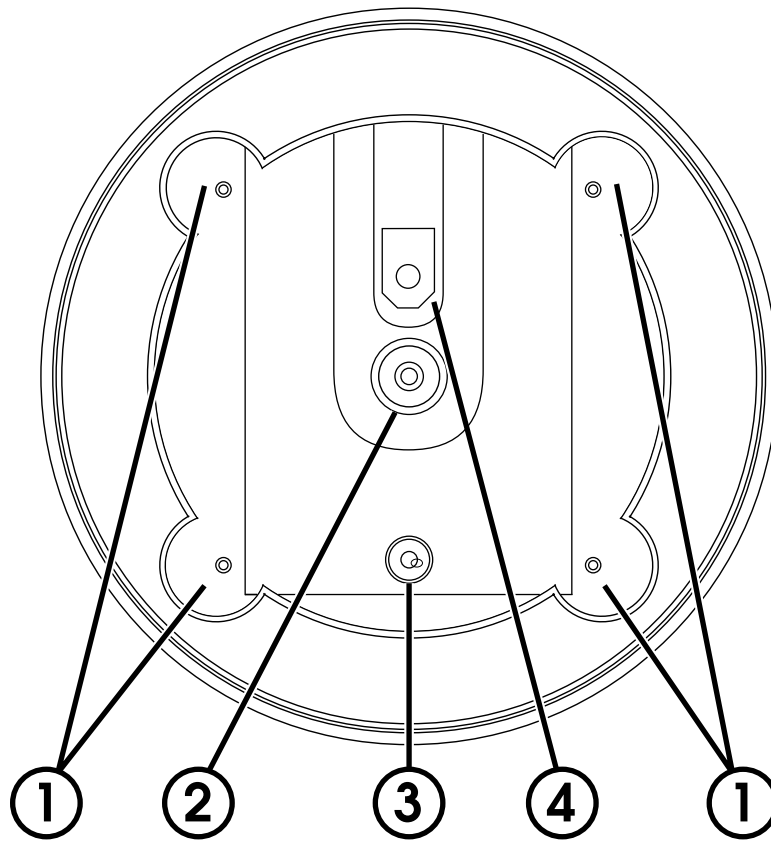

CD Transport Assembly

1 FINGER WELLS

These cutouts make it easy to grasp a CD by its edges when placing it on or removing it from the spindle. Both right-handed and left-handed users are accommodated by having both diagonals available.

LEVELLING SCREWS

For the best performance, the N°31.5's transport assembly should be level. Four levelling screws (one inside each finger well) allow you to adjust the transport assembly easily.

With the supplied $\frac{3}{32}$ " hex driver, and using the N°31.5's bubble level (3) as a gauge, adjust one or more of these screws to bring the transport assembly to level. To lower a corner, turn the corresponding screw clockwise; to raise a corner, turn the screw counterclockwise.

2 SPINDLE

This is the device that spins the CD, and on which the CD rests during play. The CD must be centered on the spindle, and it must be clamped to the spindle by the **disc damper**.

3 BUBBLE LEVEL

Use this bubble level, along with the four levelling screws (1), to make sure that the N°31.5's transport assembly is level.

4 LASER ASSEMBLY

This assembly contains the N°31.5's laser pickup, the device that reads the underside of the CD.

Caution:

Never touch or attempt to clean the laser assembly.

The Disc Damper

To clamp a CD onto its spindle, the N°31.5 uses a **disc damper** held in place by a strong magnet:

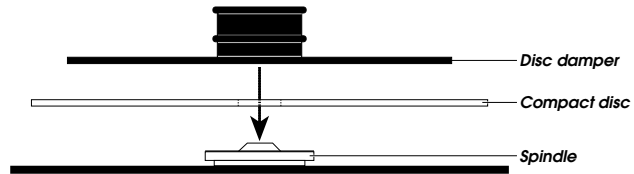

Always make sure that the disc damper is in place before closing the lid. If you close the lid without the disc damper in place, the display will show **NO DAMPER** and you'll be unable to play the CD.

When loading a CD for play, install the CD on the spindle, then place the disc damper on top of the CD.

The CD and the disc damper must be centered on the spindle. You'll feel the disc damper's magnet "catch" when both are centered.

Removing the Disc Damper

When removing a CD from the spindle, first remove the disc damper. To prevent damage to the CD, gently hold it down by the edge with the tip of one finger while pulling up on the disc damper's knob, as shown below:

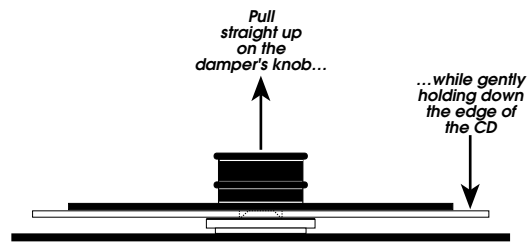

To overcome the magnet, you'll need to give it a firm pull.



Caution:

When the Disc Damper clamps the CD onto the spindle, its strong magnet forces the air from between the damper and the CD. If you don't follow the removal procedure outlined above, the CD may stick briefly to the damper's energy-absorbing surface after the magnet is released. If the CD is stuck to the damper when you remove them from the spindle, take care not to let it fall.

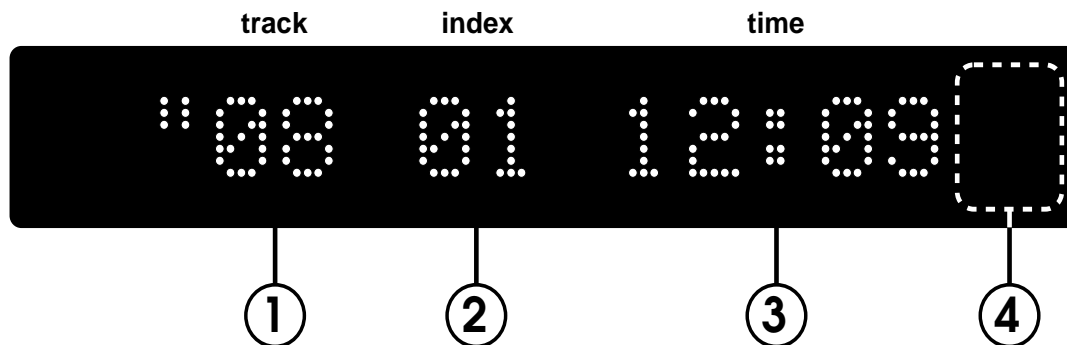

Display

1 TRACK

Before play begins, this part of the display shows the total number of tracks on the CD.

During play, this part of the display shows the number of the track in play.

While a program is in the N°31.5's memory, the letter **P** will appear preceding the track number. A small **p** indicates a saved polarity setting (possible only when the N°31.5 is linked to a compatible Mark Levinson digital processor).

While random play is active, the letter **R** will appear preceding the track number. (See *Random Play*, p. 29)

While **repeat A-B** is active, the letters **A** then **B** will alternate appearing in the space preceding the track number.

While **Pause** is active, **||** will appear preceding the track number (as pictured above).

While preview is active, the **track** part of the display will flash.

2 INDEX

If a CD includes indices, this part of the display shows the index in play, beginning with **01** and increasing as the CD plays. If the CD in play doesn't include indices, this part of the display shows **01** throughout play. For information on how to use indices, see *Basic Operation*.

Tracks may also be played from "Index 0". (See *Setting Options*.)

3 TIME

Before play, this part of the display shows the total playing time for all tracks on the CD. When play begins, this part of the display shows time-related information about the CD or the track.

You may vary the nature of the information in this part of the display using the **display mode** button. (See *Front Panel*.)

4 INFRARED RECEIVER AND TRANSMITTER

This part of the display accepts commands from the N°31.5's Remote Control. (See *Remote Control*.) When using the N°31.5 to teach a learning remote special commands, it can also transmit IR signals. (See *Using Learning Remote Controls*.) Always keep this window clean and unobstructed.

Display messages

The display also shows a variety of messages about the N°31.5's status and operation. Here are some of the messages you'll see, and what they mean.

- **CLOSING**: The Lid is in motion (closing); appears after the **Lid Open/Close** button is pressed.
- **FIRST TRACK**: The **previous** button was pressed while the first track on the CD (or in a program or a random sequence) was playing.
- **INDEX SEARCH**: The N°31.5 is scanning the CD for indices; appears after **index mode** is pressed.
- **INSERT DISC**: The Lid is open; appears after the Lid has stopped opening.
- **LAST TRACK**: The **next** button was pressed while the last track on the CD (or in a program) was playing.
- **NEW PROGRAM**: A new program was recorded in the N°31.5's memory; appears after **program save** is pressed.
- **NO DAMPER**: The Lid is closed and the Disc Damper isn't installed on the spindle; appears after the Lid has closed.
- **NO PROGRAM**: There's no program in the N°31.5's memory; appears after **program review** or **program clear** is pressed.
- **OPENING**: The Lid is in motion (opening); appears after the **Lid Open/Close** button is pressed.
- **P01 IS 1st**: Indicates a track's place in a program; appears after **program review** is pressed.
- **P02 02 IS 2**: Indicates an index's place in a program; appears after **program review** is pressed.
- **PROG CHANGED**: Changes to a program were recorded in the N°31.5's memory; appears after **program save** is pressed.
- **POLARITY PRG**: A program including only the **polarity invert** function was saved; appears after **program save** is pressed.
- **PROG DELETED**: A previously saved program was erased from the N°31.5's memory; appears after **program clear** is pressed, followed by pressing **program save**.
- **PROG CLEARED**: The temporary program was erased, or the previously saved program was temporarily overridden; appears after **program clear** is pressed.
- **PROGRAM END**: There are no more selections in the program being reviewed; appears after **program review** is pressed.
- **READING**: The N°31.5 is reading track and time information from the CD; appears after the Lid has closed.

Remote Control

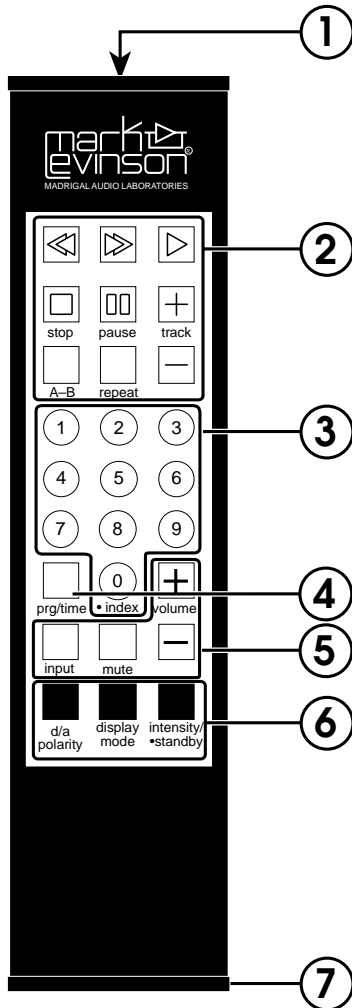

1 IR TRANSMITTER WINDOW

The N°31.5's Remote Control sends infrared (IR) commands through its projection lens, and the N°31.5 receives IR commands through its Remote sensor window. (See *Front Panel*.) If either of these lenses is obstructed, no IR commands can be received by the N°31.5. If you notice IR performance deteriorating, you may want to clean these lenses with a soft cloth and some glass cleaner. (*Spray the cleaner on the cloth first, and then wipe the lens with the moistened cloth. Do not spray the cleaner directly on either lens, as this may allow moisture to migrate into the electronics behind the lens assemblies.*)

2 TRANSPORT & PROGRAMMING BUTTONS

The buttons used for routine operation of transport functions on the N°31.5 are grouped at the top of the remote control. They include:

- ◀◀ **reverse scan**: When pressed, the N°31.5 will enter a reverse audible scanning mode similar to the familiar *rewind* function of many cassette decks, allowing a precise location within a track to be located.
- ▶▶ **forward scan**: When pressed, the N°31.5 will enter a fast forward audible scanning mode similar to the familiar *fast forward* function of many cassette decks, allowing a precise location within a track to be located.
- ▶ **play**: Press to enter the **play** mode from either **stop**, **pause**, or **standby**, or to restart play at the beginning of the track currently playing. Pressing **play** while in an **A-B** loop will return you to point **A**.
- **stop**: Press to **stop** the disc. The same button will operate the **Lid** if stopping the disc has no relevance (e.g., if it is already stopped, or if there is no disc inside the N°31.5).
- ⏸ **pause**: Press to **pause** play in the current location. If left in **pause** mode for more than two minutes, the N°31.5 will enter **extended pause** mode, shutting down both the laser and the drive motors to enhance longevity and reliability. Upon pressing **pause** or **play** a second time, the disc will spin up and begin playing from the location where it had been paused. (You may also force the N°31.5 into **extended pause** mode by pressing and holding the **pause** button for a few seconds.)
- (+) **track +**: When pressed, this will take you to the beginning of the **next** track. Also used to add a track to a playlist when creating a custom program. (See *Introduction to Programming*.)

A-B: Press once to establish a beginning point (point **A**) for an endless playback loop. The display will flash the letter **B** to indicate that it is ready to accept your designated ending point (point **B**). Once this has been done, the N°31.5 will repeat the segment of the disc between points **A** and **B** until you press **A-B** or **stop**. (Note that **A** must precede **B** on the disc.) Directly accessing a point beyond the end of your **A-B** loop (**next**, **direct time**, or **direct track**) will cancel the **repeat A-B** function and return the N°31.5 to play at your selected point.

repeat: Press once to enter **repeat disc** mode (repeating the entire disc, or an entire playlist if one is entered). This action will illuminate the **repeat disc LED**. Press a second time to enter the **repeat track** mode (repeating a single track ad nauseam). A third press will cycle you back to normal operation, as will pressing **stop**.

(←) **track -:** When pressed, this will take you to the beginning of the **previous** track. Also used to add a track to a playlist when creating a custom program. (See *Introduction to Programming*.)

3 NUMERIC KEYPAD

The numbers 0, 1, 2, 3, 4, 5, 6, 7, 8, and 9 may be used to directly access individual track numbers of discs played by the N°31.5. For example, to go directly to track 13, press **1** followed by **3**, and then press **play**. You do not have to add a 0 before a single-digit track number: **7**, followed by **play**, will take you directly to track number 7. (In fact, if the N°31.5 is already in play, simply pressing the number button will be sufficient.)

The N°31.5 displays a certain amount of intelligence with respect to direct track access. If the first number entered identifies a particular track unambiguously (such as 2 on a 12-track disc), the N°31.5 is “smart” enough to immediately move to that track. If the first number entered could be the first of two digits (such as 1 on a 12-track disc), the N°31.5 will wait for a moment to determine whether you wish to enter a second number. If not, it will then go to the single-digit track you selected.

If you request a non-existent track (pressing **2, 1** on a 12-track disc, for example), the N°31.5 will display **NO TRACK XX** (where **XX** is the track you requested that does not exist) and resume play.

Selecting a particular track does not affect the operating mode. That is to say, pressing **7** while in **play** begins playing track 7; pressing **4** while in **pause** leaves you paused at the beginning of track 4. Similarly, using direct track access during the playing of a program will temporarily override the program; pressing stop will return you to your original programmed playlist as though nothing had ever happened.

Random Play

Incidentally, if you press **0** followed by **play**, the N°31.5 will enter a **random play** mode in which the order of the current disc's playlist is scrambled, and then played. The first character of the display (that shows a **P** when playing a playlist) will show **R** to indicate **random play**. Moreover, placing the N°31.5 into **random play** mode while the **disc repeat** function is engaged will cause it to play the various tracks on the disc randomly indefinitely (until you stop it). This can be a great way to provide background music during a dinner party, for example.

4 PROGRAM/TIME

While remaining in **stop**, you may advance the display to any desired track using the **track –** and **track +** keys. Pressing **prgm/time** followed by the **track +** (or **track –**) button will add (or delete) the displayed track to that disc's playlist.

On the other hand, pressing **prgm/time** followed by a *number* on the numeric keypad gives you direct time access to any point on the disc. Note that this time access is context-sensitive: that is, when the display is **time elapsed in track** mode, pressing prg/time followed by 1, 2, 3 will cue up the N^o31.5 at 1:23 into the current track; doing so in **time remaining on disc** mode will cue up the N^o31.5 at 1:23 before the end of the disc.

5 "PREAMP" FUNCTIONS

(+) **raise volume**: Pressing this button on the N^o31.5 remote control will transparently and automatically raise the volume of a Linked Mark Levinson preamplifier, minimizing the need to juggle multiple remotes. This function is available even when the N^o31.5 is in standby, in which case its display will activate long enough to confirm your command visually. Since this function depends on the ability of the N^o31.5 to pass the instruction to the N^o38S (for example), the two components must be connected by a Link cable, and operate within a system which has a "master" digital processor. (See *Setting Options* for more information.)

input: Pressing this button on the N^o31.5 remote control once will display the current status of the input selection control, for example **No30 on No31** (*to indicate that the N^o30 or N^o30.5 digital processor has the N^o31.5 as its selected source*). Clicking the button again while this information is displayed will automatically cycle through the various active (e.g., *not* named **NOT USED**) digital inputs on a Linked Mark Levinson digital processor, minimizing the need to juggle multiple remotes. This function is available even when the N^o31.5 is in standby, in which case its display will activate long enough to confirm your command visually. Since this function depends on the ability of the N^o31.5 to pass the instruction to the processor, the two components must be connected by a Link cable. (See *Setting Options* for more information.)

Analog Input Switching

Alternatively, you may force the **input** button to select from among your *analog* inputs on a Linked Mark Levinson preamplifier (assuming you have one) by:

- Clicking on the **input** button to display the current status of the input selection control. (*It will show something like **No30 on No31**, for example.*)
- Pressing *and holding* the **input** button until the N^o31.5 display indicates that it is now controlling the preamplifier, by displaying something like **No38 on No30** (*for example; this would indicate that the No38 preamplifier has the No30 digital processor as its selected source*)
- Then clicking the **input** button to cycle the preamplifier through its active inputs (e.g., *not* named **NOT USED**)

Direct access to inputs

This function is available even when the N°31.5 is in standby, in which case its display will activate long enough to confirm your command visually.

You may change the **input** button back to controlling the *digital* source selection at any time by repeating this procedure.

Whenever the N°31.5 is in either its analog- or digital-input switching mode (as shown by the display indicating something like **No30 on No31** rather than its normal display), you may go directly to any desired input by pressing the corresponding number button on the numeric keypad of the remote control.

mute: Pressing this button will engage the **mute** of a compatible Mark Levinson preamplifier without stopping the transport. Pressing it a second time will restore the volume to its previous setting. This function is available even when the N°31.5 is in standby, in which case its display will activate long enough to confirm your command visually. Since this function depends on the ability of the N°31.5 to pass the instruction to the N°38 (for example), the two components must be connected by a Link cable, and operate within a system which has a “master” digital processor. (See *Setting Options* for more information.)

(←) **lower volume:** Pressing this button on the N°31.5 remote control will transparently and automatically lower the volume of a Linked Mark Levinson preamplifier, minimizing the need to juggle multiple remotes. This function is available even when the N°31.5 is in standby, in which case its display will activate long enough to confirm your command visually. Since this function depends on the ability of the N°31.5 to pass the instruction to the N°38 (for example), the two components must be connected by a Link cable, and operate within a system which has a “master” digital processor. (See *Setting Options* for more information.)

6 MISCELLANEOUS CONTROLS

d/a polarity: Pressing this button on the N°31.5 remote control will transparently and automatically invert the polarity of a Linked Mark Levinson digital audio processor, minimizing the need to juggle multiple remotes. Since this function depends on the ability of the N°31.5 to pass the instruction to the N°36 (for example), the two components must be connected by a Link cable. (See *Setting Options* for more information.)

display mode: Pressing this button duplicates the function of pressing the **mode** button on the N°31.5, cycling through the four **time modes** (*time elapsed* or *time remaining*, either on the *track* or on the *disc*). *Pressing and holding* this button will allow you to set your Link options. (See *Setting Options* for more information.)

intensity/•standby: Pressing this button momentarily cycles the N°31.5 (and any Linked Mark Levinson components) through their four levels of **display intensity** (bright, medium, dim, off). When pressed *and held* for about one second (denoted by the bold dot •), this button will place the N°31.5 into or out of **standby**. If you continue to hold this button after the N°31.5 enters **standby**, it will force the entire Linked system into **standby**. This function is available even when the N°31.5 is already in standby, in which case its display will activate long enough to confirm your command visually.

7 BATTERY COMPARTMENT

The two AA batteries used by the Remote Control must be placed inside the compartment at the bottom of the remote's housing. Using the 5/64" hex wrench provided in your accessory kit (look inside the slot within the foam rubber), carefully remove the two screws on the bottom of the housing and insert the batteries, being careful to orient them as indicated inside the battery compartment. Then replace the screws using the hex wrench.

Conditions that Affect IR Performance

IR communication between the Remote Control and the N°31.5 can be affected by:

- Direct sunlight
- Interior lighting
- Wall, window, ceiling, and floor treatments
- The angle of the Remote Control relative to the N°31.5

If the N°31.5 will be subject to direct sunlight, place it no more than 10 feet from where you'll normally operate the Remote Control. Where bright sunlight virtually floods the room, IR communication may be inconsistent.

In a room lighted primarily with incandescent fixtures, place the N°31.5 no more than 25-30 feet (7-9 meters) from where you'll normally operate the Remote Control. In a room with fluorescent fixtures, this range will be reduced. Where bright fluorescent lighting virtually floods the room, IR communication may be inconsistent.

IR, like visible light, reacts differently when it meets different surfaces. Carpeting and draperies, for example, tend to diffuse (scatter) IR and interfere with its transmission. Glossy or reflective surfaces, such as mirrors and smooth walls, "bounce" (reflect) IR and won't interfere with its transmission. When placing the N°31.5, it is important to account for potential IR bounce and diffusion. For example, in a room with thick carpeting, heavy draperies, and many pieces of furniture, you may need to place the N°31.5 closer to where you'll normally operate the Remote Control than you would in a sparsely furnished room with bare walls and hardwood flooring.

If possible, install the N°31.5 directly opposite from where you'll normally operate the Remote Control. In practice, the Remote Control will operate the N°31.5 at up to 30 degrees to either side of this direct line. To either side of this line, successful IR communication will depend on bounce and ambient lighting. (Please refer to diagram on next page.)

*Optimum IR
reception window*

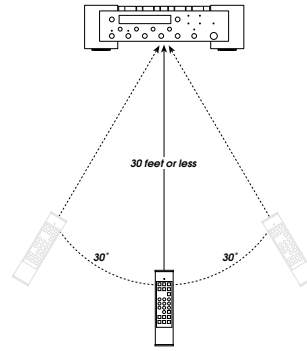

If the requirements of your installation preclude a clean line of sight between the N°31.5 and your listening position, you may want to consider using an infrared repeater to route the remote control's commands to the N°31.5. Please ask your dealer for more information on third-party IR repeaters.

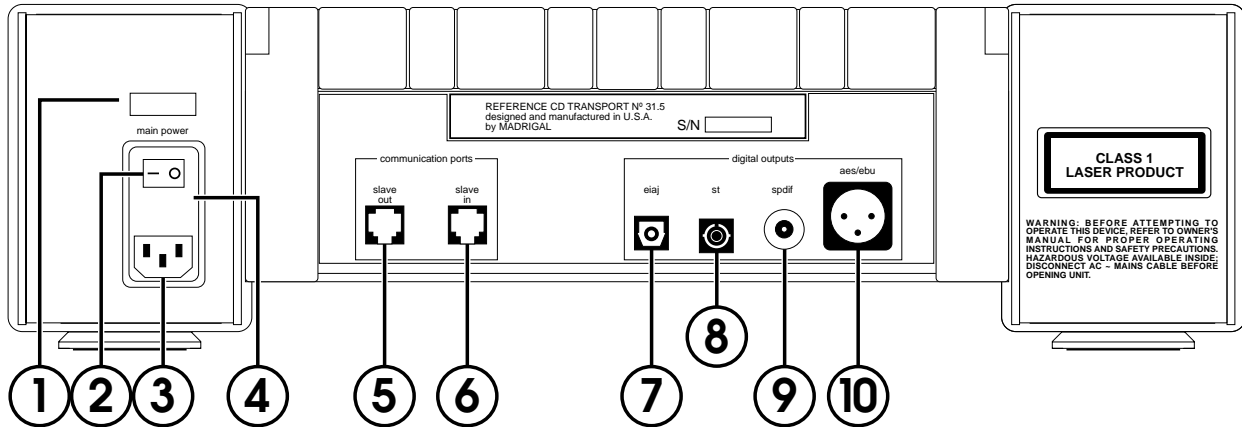

Rear Panel

1 OPERATING VOLTAGE INDICATION

The N°31.5 is set at the factory (internally) for 100, 120, 200, 220, or 240VAC mains operation as appropriate for the country in which it is to be sold. Make sure that the label on the rear of the left tower (as seen from the rear) of the N°31.5 indicates the correct AC operating voltage for your location, as attempting to operate the N°31.5 at an incorrect voltage can damage the unit.

The N°31.5 Reference CD Transport is also set at the factory for operation on either 50 or 60 Hz AC line frequencies, as appropriate for the country in which it is to be sold. It will not operate if it senses an incorrect line frequency.



Warning!

Neither the voltage nor the line frequency setting may be changed by the user. There are no user serviceable parts inside the N°31.5. Only qualified, authorized service personnel may open the N°31.5 CD Transport, as hazardous voltages exist within the unit.

2 MAIN POWER

This switch turns the N°31.5 on and off. The switch must be in the "1" (on) position for the N°31.5 to function. (See *Setup and Installation*.)

Caution:

Never operate the main power switch without first making sure that power is turned off to your receiver, integrated amplifier, or preamplifier/power amplifier.

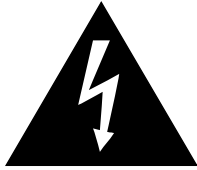

Warning!

3 AC POWER CORD SOCKET

This socket accepts AC mains power via the supplied AC power cord.

4 FUSE COMPARTMENT

The panel surrounding the **main power** switch is also a hinged cover for the N°31.5's fuse compartment. The N°31.5 uses two 1.0-ampere slo-blow fuses (type T1A slow-blo 5x20mm).

Never attempt to open the fuse compartment without first removing the AC power cord from the N°31.5. If you need to replace the fuses, always use the same type of fuse.

To open the fuse compartment, insert the tip of a small, flat-bladed screwdriver into the slot at the top edge of this panel. Gently pry open the top edge of the compartment cover.

5-6 SLAVE OUT and SLAVE IN

These **communication ports** allow the N°31.5 to “link” to certain compatible Mark Levinson components via the Madrigal Communications Link system (MCL). (See *Setting Options*.) When making these connections (which resemble large versions of standard U.S. telephone connectors), make sure that the Link cable's locking tabs engage securely in the components' communication ports.

To set up a Linked system consisting only of transport and processor:

1. Using a Link cable (see *Madrigal Communications Link*), connect the **master** port on the Mark Levinson digital processor to the N°31.5's **slave in** port.
2. Make sure that the digital audio connection between the two operates (you should see “44.1” on the processor, indicating that it has locked onto the N°31.5's output).
3. Press **play** on the N°31.5—that's it.

To add multiple Mark Levinson transports to the system, simply connect the first N°31.5's **slave out** port to the second N°31.5's **slave in** port. Subsequent transports are connected from **slave out** to **slave in** in a “daisy chain.”

If you are linking a Mark Levinson preamplifier, it must be the last components in this “daisy chain.” Run a Link cable from the last **slave out** port to the **slave** port of the Mark Levinson preamplifier. (Mark Levinson power amplifiers employ a different, special linking connection from the preamplifier.)

Caution:

Connecting the communication ports other than as described in this manual may damage the N°31.5 and the digital processor, and will void the products' warranties.

7 DIGITAL OUTPUT, EIAJ OPTICAL

This output provides the **digital audio signal (DAS)**, via optical cable equipped with the EIAJ-type optical connector (sometimes called “Toslink[®]”) to the digital processor:

8 DIGITAL OUTPUT, ST OPTICAL

This output provides the **digital audio signal (DAS)**, via optical cable equipped with the ST-type optical connector (sometimes called “AT&T”) to the digital processor:

9 DIGITAL OUTPUT, S/PDIF ELECTRICAL

This output provides the **digital audio signal (DAS)** via cables equipped with RCA-type connectors to the digital processor:

This input conforms to the Sony/Philips Digital Interface Standard (S/PDIF), which calls for a 75Ω transmission of the DAS. Use a digital interconnecting cable specifically designed for the 75Ω S/PDIF standard, such as Madrigal MDC-2 cable, when using this input.

10 DIGITAL OUTPUT, AES/EBU ELECTRICAL

This output provides the **digital audio signal (DAS)** via cables equipped with XLR-type connectors to the digital audio processor:

This input conforms to the Audio Engineering Society/European Broadcast Union (AES/EBU) professional digital audio standard, which calls for a 110Ω transmission of the DAS. Use a digital interconnecting cable specifically designed for the 110Ω AES/EBU standard, such as Madrigal MDC-1 cable, when using this input, with pin assignments as indicated below:

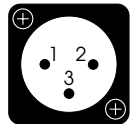

Pin 1: chassis ground (AC-coupled)

Pin 2: non-inverted digital

Pin 3: inverted digital

Connector ground lug: chassis ground

It has been Madrigal's experience that the AES/EBU interconnection standard offers the best quality of all digital transmission interfaces when fully optimized, and we recommend its use wherever possible between Mark Levinson components.

However, optimizing any digital interface completely represents a significant engineering challenge. It is entirely possible that a different type of input may actually outperform a less-than-optimized AES/EBU implementation on some brands of digital processors. For this reason, we have gone to great lengths to fully optimize all four of the digital outputs on the N^o31.5. If you are using you N^o31.5 with a different brand of processor, we recommend experimenting to determine which type of input on that processor results in the best audible performance.

Basic Operation

Before operating your N°31.5, become familiar with its controls and their locations. (See *Front Panel*, *Top Panel*, *CD Transport Assembly*, and *Remote Control*.)

Loading a CD

To load a CD for play:

1. Make sure that the **main power** switch is set to the “I” position.
2. Enable the N°31.5's controls by pressing **standby**.
3. Press **Lid Open/Close** to open the Lid.
4. Remove the Disc Damper from the spindle.
5. Place a CD onto the spindle, label side up. Handle the CD by the outer edges only.
6. Place the Damper on top of the CD. Make sure that it's centered and seated securely.
7. Close the Lid by pressing **Lid Open/Close** again.

In a few seconds, the display will show the total number of tracks and their total playing time. The CD is now ready for play.

Temporarily overriding a previously saved program

Note: If you have previously saved a program for the CD, the letter **P** will appear preceding the track number on the display. (See *Programming*.)

To override a previously saved program, press **program clear**; or on the Remote Control, press the **0** (zero) numbered key, then press **prg/time**. All of the CD's tracks will be accessible for basic operation, but the program will still be retained in the N°31.5's memory.

Playing all tracks in order

To play all tracks on the CD, press the play button. All tracks will play in order. Play will stop automatically at the end of the CD.

Beginning play with other than the first track

To begin play with a track other than the first track:

1. Before pressing **play**, press **next** until the number of the desired track shows on the display (**track +** on the remote). If you pass the track you want to play, you can “back up” by pressing **previous** (**track -** on the remote). You may also select the track using the numbered buttons on the Remote Control.
2. Press **play** to begin playing that track. The remaining tracks will play in order. Play will stop automatically at the end of the CD.

Replaying a track

To return to the beginning of a track while it's playing, press **play**. Play will be suspended briefly, then that track will replay followed by the remaining tracks on the CD.

Random play	<p>Using the Remote Control, you may have the N°31.5 play tracks totally at random. To do this, press the 0 (zero) numbered key, then press play.</p> <p>While random play is active, the letter R will appear preceding the track number on the display.</p> <p>To cancel random play, press Stop.</p>
Skipping to another track	<p>You may skip to another track any time while a CD is playing. To move to another track, press next ▶ (track + on the remote) to go forward, or previous ◀ (track - on the remote) to go backward until the number of the track you want to play shows on the display. (You may also select the track using the numbered buttons on the Remote Control.) Play will resume as soon as the pickup reaches that track.</p>
Searching for a passage	<p>You may search for a particular passage on the CD using Search Forward (▶▶) and Search Reverse (◀◀). Scan the CD until the laser pickup reaches the passage you want to hear. The playing speed increases when you hold down Search Forward or Search Reverse, and the volume is reduced.</p> <p>Note: If your N°31.5 is Linked to a compatible Mark Levinson digital processor (via the communication ports), you have the option of muting the volume completely during search. (See Setting Options.)</p> <p>As soon as you release the button, play resumes.</p> <p>If you search past the beginning (or end) of a track, the laser pickup will move on to the previous (or next) track.</p> <p>If you try to search forward past the end of a CD or program, the laser pickup will stop at the end of the last track.</p> <p>If you try to search backward past the beginning of a CD or program, the laser pickup will stop at the beginning of the first track. When you release Search Reverse, play will resume beginning with the first track.</p>
Previewing a CD	<p>Using the N°31.5's preview function, you may play only the introduction of each track on a CD, then resume normal play when you hear the track you like.</p> <p>Once a CD is loaded and ready for play, press preview. Beginning with the first track, the N°31.5 will play the first ten seconds of the track, skip to the second track and play the first ten seconds of that track, and so on. While the preview function is active, the track part of the display will flash.</p> <p>To resume normal play, press preview again or press play.</p>

	<p>Using indices If a CD has indices, you may use them to begin play in the middle of a track.</p> <ol style="list-style-type: none"> 1. Press index mode. (If there was no CD in play, the display will show INDEX SEARCH.) After a brief delay while the transport searches the disc, the LED above the button will flash to indicate index mode. 2. Using next and previous (or the numbered buttons on the Remote Control), select an index. 3. Press play to begin play at the index you selected.
<p>Beginning play at a specific location in a track</p>	<p>You may use prg/time on the Remote Control to begin play at a specific <i>time</i>—whether or not it corresponds to an index.</p> <ol style="list-style-type: none"> 1. Using track + or track -, or the numbered buttons on the remote control), select a track. 2. Press prg/time, then press the numbered buttons corresponding to when you'd like play to begin. (The numbers you select will appear in the time part of the display.) 3. To begin play at that point, press play. <p>Note: The time you select depends on the selection you've made with the display mode button: elapsed or remaining, CD or track.</p> <p>For example, if you want to begin play one minute and thirty seconds into track 2, first press display mode until the elapsed time and on track LEDs light. Then select track 2 by pressing track + or track - (or by entering 02). Press prg/time, enter 130, then press play.</p>
<p>The pause function</p>	<p>To suspend play while a CD is playing, press pause. To resume play at the same point, press pause again.</p> <p>If left in pause for several minutes, the transport will stop spinning and the laser will turn off (thereby enhancing the longevity of both). This will be indicated by the pause indicator in the display (“II”) flashing on and off. Alternatively, this extended pause feature may be engaged by pressing and holding the pause button until the indicator begins to flash in the display. Pressing pause again will resume play at the point where pause was first pressed, (after a short delay to allow the disc to get up to speed).</p> <p>To “cue up” the beginning of a CD or track, press pause <i>before</i> pressing play (5). To begin play, press pause again. (You may also select another track or index while play is suspended.)</p>
<p>Repeating an entire CD</p>	<p>To repeat (continuously) all tracks on a CD, press repeat disc. While the repeat disc function is active, the LED above the button is lit. To return to normal play, press repeat disc again.</p>
<p>Repeating a track</p>	<p>To repeat (continuously) the track in play, press repeat track. While the repeat track function is active, the LED above the button is lit. To return to normal play, press repeat track again.</p>

Repeating a specific passage

To repeat (continuously) a specific phrase or passage on a CD, press **repeat A-B** at the beginning of the passage you would like to repeat. At the end of the passage, press **repeat A-B** again. The passage you selected will repeat continuously.

While the **repeat A-B** function is active, **A** then **B** will appear preceding the track number on the display. To return to normal play without interruption, press the **repeat A-B** button again.

While in the repeat A-B mode, the following keys behave as outlined below:

- ▶ **play** will restart play at point A (much as doing so normally returns you to the beginning of the current track).
- ◀◀ **search reverse** will “rewind” the disc back, beginning play when you release the button. This allows you to review the lead-in to your A-B section, as when learning a piece of music by ear.
- ▶▶ **search forward** will “fast forward” the music as far as the “B” point, stopping there for easy access to the end of your A-B loop.
- **stop** will leave the **repeat A-B** mode and enter **stop**.
- ◀ **previous** will move you to the previous track (or index if in index mode) whether or not it lies within the A-B loop.
- ▶ **next** will move you to the next track (or index if in index mode). If this location lies beyond the defined A-B loop, the N°31.5 will leave **repeat A-B** mode, reverting to normal play.
direct track access will override your A-B loop if you go beyond the defined A-B loop.
direct time access will also override your A-B loop if you go beyond the defined A-B loop.

Inverting playback polarity

If your N°31.5 is linked to a compatible Mark Levinson digital processor via the **communication ports**, you may change the playback polarity. (See *Setting Options*.)

After loading a CD, press the **polarity invert** button on the digital processor's front panel, or press **d/a polarity** on the N°31.5's Remote Control, then press **play**. The CD will play with inverted polarity.

If you want this CD to always play with inverted polarity, press **program save** before pressing **play**. The display will show **POLARITY PRG**, a small P will appear preceding the track number on the display, and inverted polarity will be saved as a “program” for that CD. (See *Programming*.)

Stopping play

To stop play before the end of the CD, press **Stop**. The display will show the total number of tracks and their total playing time.

You may also stop play by pressing **Lid Open/Close**. In this case, play will stop and the Lid will open.

Introduction to Programming

Rather than playing an entire CD, you may choose to play only certain selections. To do this, you create a “program” (or playlist) and store it in the N°31.5’s memory.

Before using your N°31.5’s programming features, become familiar with its controls and their locations (see *Front Panel, Top Panel, CD Transport Assembly*, and *Remote Control*), as well as their basic functions (see *Basic Operation*).

When playing a program, the N°31.5’s basic functions operate as described in *Basic Operation*, except that they work within the context of the program’s playlist rather than the entire CD. For instance, pressing **next** during play skips to the next track or index in the sequence, whether or not it is the next track or index on the CD. In the same way, pressing **repeat disc** will repeat the entire program, not the entire CD.

The N°31.5 allows up to 99 selections (tracks and indices) per program. A program may include both tracks and indices.

Assembling a program is possible only before play begins.

Note: The only programming functions that operate while a CD is playing are **program clear** and **program save**.

How the N°31.5 remembers programs

When you load a CD, the N°31.5 assigns it a unique identification code. If you assemble a program for a particular CD *and* save it into the N°31.5’s memory, the N°31.5 “remembers” that CD’s program.

The next time you load that CD, the N°31.5 will recognize the CD’s identification code and automatically loads the previously saved program. (The letter **P** will appear preceding the track number on the display.) [**Note:** *Even if you have previously saved a program for a CD, the N°31.5 allows you to override it (and have access to all tracks on the CD) without erasing it from the memory.*]

The N°31.5’s memory can store programs for thousands of CDs. Saved programs remain in memory when you place the N°31.5 into standby, when you turn off the main power switch — even if AC power is interrupted.

Assembling a new program

To assemble a new program, make sure a disc is loaded and that the N°31.5 is in stop (rather than already playing):

1. Using the **next** and **previous**, select the first track in your program.
2. Add the first selection to your program by pressing **program +** (on the Remote Control, press **prg/time**, then press **+**).
3. Assemble the rest of your program (up to 99 selections) by repeating steps 1 and 2.
4. When you’ve finished building your playlist:
 - a. If you want to play your program without recording it in the N°31.5’s memory, go on to step 5.
 - b. If you want to record your program in the N°31.5’s memory, press **program save**; the display will show **NEW PROGRAM**.
5. To play the program, press **play**.

Delete Programming

If you want to play *most* of a CD, and just “ignore” a few tracks, you may want to use this shortcut:

1. Using the **next** and **previous** (or the numbered buttons on the Remote Control), select the first track you want to *eliminate* from your program.
2. “Delete” the track by pressing **program -**.
3. Repeat steps 1 and 2 for each track you want to ignore.
4. When you have finished eliminating tracks:
 - a. If you want to play your program without recording it in the N°31.5’s memory, go on to step 5.
 - b. If you want to record your program in the N°31.5’s memory, press **program save**; the display will show **NEW PROGRAM**.
5. To play the program, press **play**.

Advanced Programming

After you have created a few programs as outlined in the previous section, you may want to review them, add extra tracks to existing programs, or in other ways change the nature of what you have done. The N°31.5 provides great flexibility in these regards.

Reviewing a program

To review your program before playing it:

1. Load a CD for which you've already saved a program (the letter **P** will appear preceding the track number on the display); or load an unprogrammed CD, then assemble and save a program.
2. Press **program review**. The display will show the first selection in your program. For example, if track 3 is the first selection in your program, the display would show **P03 IS 1st**. If index 2 on track 5 is the first selection, the display would show **P05 02 IS 1**.
Note: If you press **program review** when there is no program in the N°31.5's memory, the display will show **NO PROGRAM**.
3. To view the next selection, press **program review** again, and so on. Press **program review** for each selection in your program. After you view the last selection, the display will show **PROGRAM END**.

Adding a selection

You may add a selection to the end of a previously saved program. To add a selection:

1. Load a CD for which you've already saved a program (the letter **P** will appear preceding the track number on the display); or load an unprogrammed CD, then assemble and save a program.
2. Using the **next** and **previous** (or the numbered buttons on the Remote Control), select the track you want to add to your program. You may also include indices in your program. Press **index mode**, then use **next** and **previous** (or the numbered buttons on the Remote Control) to select an index. [**Note:** If your N°31.5 is linked to a compatible Mark Levinson digital processor via the **communication ports**, you may set the playback polarity independently for each track. See *Setting Options*. In this case, press the **polarity invert** button on the digital processor's front panel, or press **d/a polarity** on the N°31.5's Remote Control, before continuing to step 3.]
3. Add the selection to your program by pressing **program +** (on the Remote Control, press **prg/time**, then press **+**).
Note: You must press **program +** (or **prg/time** and **+**) within five seconds after making a selection, or the selection won't be recorded.
4. Repeat steps 2 and 3 for each selection you want to add to your program. Make sure to press **program +** (or **prg/time** and **+**) after each selection.
5. When you've finished adding selections, press **program save**; the display will show **PROG CHANGED**. This last step is what makes your change permanent.

Erasing a selection

You also may erase a selection from a previously saved program. To erase a selection:

1. Load a CD for which you've already saved a program (the letter **P** will appear preceding the track number on the display); or load an unprogrammed CD, then assemble and save a program.
2. Using the **next** and **previous** (or **track +** and **track -** on the remote, or the numbered buttons on the remote), select the track you want to erase from your program.
3. Erase the selection to your program by pressing **program -** (on the remote control, press **prg/time**, then press **-**).
Note: You must press **program -** (or **prg/time** and **-**) within five seconds after making a selection, or the selection won't be recorded.
4. Repeat steps 2 and 3 for each selection you want to add to your program. Make sure to press **program -** (or **prg/time** and **-**) after each selection.
5. When you've finished adding selections, press **program save**; the display will show **PROG CHANGED**. This last step is what makes your change permanent.

Temporarily overriding a previously saved program

To override a previously saved program (temporarily), press **program clear** (on the Remote Control, press the **0** numbered key, then press **prg/time**); the display will show **PROG CLEARED**.

All of the CD's tracks will be accessible for basic operation, but the program will still be retained in the N°31.5's memory. (See *Basic Operation*.)

Note: If you press **program save** after pressing **program clear**, the display will show **PROG DELETED** and the program will be erased from the N°31.5's memory.

Erasing a program

To erase a previously saved program *permanently* from the N°31.5's memory:

1. Press **program clear**; the display will show **PROG CLEARED**.
2. Press **program save**; the display will show **PROG DELETED**.

Once again, this last step of pressing **program save** is what makes your change permanent (as opposed to merely overriding the program this once).

Setting Options

The N°31.5 gives you the ability to “customize” its operation to suit your particular needs and/or preferences. One of these options pertains exclusively to how the N°31.5 itself operates: Index 0. The other options address the way in which the N°31.5 interacts with other Linked Mark Levinson components such as the N°30.5 Reference Digital Processor and the N°38S Preamplifier.

Note: To take advantage of linked functions, the various components must be connected via their communication ports. (See *Rear Panel* and *Setup and Installation*.)

The stand-alone option that is always available addresses whether the N°31.5 plays the space between tracks called “Index 0.” This space is analogous to the “lead-in grooves” of vinyl LPs.

- **Index 0:** When this option has been selected, pressing **play** will begin each track at **Index 0** rather than at the usual Index 1, resulting in a brief “countdown” to the beginning of the music.
If you prefer all track and index operations to use Index 0 as the effective beginning of a given track (to hear the applause before a song on a live recording, for example), you may select **Index 0** in the **Set Options** menu, described on the next page.

There are six linked functions. These address the way in which the N°31.5 interacts with other components within the Madrigal Communications Linking system. They are:

- **Record link (N°30 and N°30.5 only):** While the N°31.5 is selected as the N°30’s recording source (a CD must be in play), this link helps prevent you from inadvertently disrupting the recording process. If you attempt to use any of the N°31.5’s functions that might disrupt the recording process (**stop**, **Lid Open/Close**, etc.), the N°31.5 will block that function and its display will show **RECORDING**. Likewise, if you attempt to place the N°30 into **standby**, the N°31.5 will block that function and N°30’s display will show **RECORDING**.

To override the record link, press the function button **twice**.
(For example, if you **do** want to stop the CD that’s playing, even though it’s being recorded, press the **stop** button twice in succession.)

When the N°31.5 is first turned on, the record link setting is **off**.

- **Mute link:** When this link is engaged, the Linked processor will automatically mute the volume *during search modes* (that is, whenever you press **search forward** or **search reverse**). It has no effect on the remote control’s **mute** button.

When the N°31.5 is first turned on, the mute link setting is **off** so you can hearing the audible cueing function provided by the N°31.5 during searches.

- **Standby link:** This feature links the standby modes of the N°31.5 and the digital processor. If both the N°31.5 and the digital processor are in standby mode, pressing the N°31.5’s **standby** button will take both components out of standby mode (making them ready to operate). If both the N°31.5 and the digital processor are “on” (not in standby mode), pressing the N°31.5’s **standby** button will

place only the N°31.5 into standby mode (since you may wish to listen to another input on your processor).

When the N°31.5 is first turned on, the standby link setting is **on**.

- **Alias link:** Mark Levinson digital processors allow you to set an “input alias” for each of their sources; this alternative name appears on their display. The N°31.5’s alias link automatically overrides the alias setting for its input. When you select the N°31.5’s input, the processor will show **No31** on its display.

When the N°31.5 is first turned on, the alias link setting is **on**.

- **Play link:** When you press the N°31.5’s **play** button, this link automatically selects the N°31.5’s input on the digital processor.

Note: If you’ve connected the N°31.5 to two or more of the digital processor’s inputs, the play link will look first for AES/EBU interconnection, then S/PDIF, then ST, and finally EIAJ.

When the N°31.5 is first turned on, the play link setting is **on**.

- **Display link:** This links the **display intensity** functions of the N°31.5 and the digital processor. When the components are linked, both displays will be set to the same brightness. Pressing **display intensity** on either component will affect both displays.

When the N°31.5 is first turned on, the display link setting is **on**.

- **Polarity link:** This links the **d/a polarity** button on the N°31.5’s Remote Control to the **polarity invert** function of the digital processor.

The polarity link also allows inverted polarity to be saved with a program. When inverted polarity is part of a saved program, this link turns on the digital processor’s **polarity invert** function. (See *Programming*.)

The polarity link setting is always **on**, and can’t be changed.

In addition to the Setting Options, the N°31.5 has the ability to play “Index 0,” the CD equivalent of the “lead-in grooves” on an LP.

The N°31.5 allows you to change the Index 0 option and its six Link options to suit your own preferences. [**Note:** *The polarity link setting is always on, and can’t be changed.*]

1. Make sure that the **main power** switch is set to the “on” (“I”) position.
2. Enable the N°31.5’s controls by pressing **standby**.
Note: *To change your N°31.5’s link settings, your Mark Levinson digital processor also must be connected (linked) and turned on.*
3. Press and hold the front-panel **display mode** button and hold it until **SET OPTIONS** appears on the display. [**Note:** *In several seconds, if you make no changes to the link settings, the display will go back into its standard mode. To return to **SET OPTIONS**, press and hold **display mode** again.*]
4. Click the **display mode** button a few times. The display will show each of your N°31.5’s options, in this order:

INDEX 0 –	(available even without Linking)
RECORD LINK –	(seen only when Linked)
MUTE LINK –	(seen only when Linked)
STANDBYLINK +	(seen only when Linked)
ALIAS LINK +	(seen only when Linked)
PLAY LINK +	(seen only when Linked)
DISPLAYLINK +	(seen only when Linked)

A **-** sign beside an option indicates that it is currently *off*; a **+** sign indicates that it is currently *on*.

If you continue clicking **display mode** after the display shows **DISPLAYLINK+**, the links are shown again beginning with **INDEX 0**, then **RECORD LINK**, then **MUTE LINK**, and so on.

5. Stop clicking **display mode** when the display shows a link you would like to change.
5. To turn the link *on*, press the **program +** button; to turn the link *off*, press the **program -** button.
6. Repeat steps 4 and 5 for each link setting you want to change.

When you've finished, wait several seconds for the display to return to its standard mode.

Your link settings remain in memory when you place the N°31.5 into **standby**, when you turn off the **main power** switch — even if AC power is interrupted.

Auto-Standby

The N°31.5 also may be set to automatically enter standby when left in stop for a user-selectable period of time. As shipped from the factory, its standby function is manual (that is, it only enters or leaves standby when told to do so by the user). To change between manual and timed/automatic standby:

1. Press *and hold* the **standby** button until the display reads **MANUAL**.
2. Release the **standby** button and then “click” **search forward** to advance the timer. Single clicks will advance it by one minute. Pressing and holding the button will stream the numbers by to a maximum of 120 minutes. **Search reverse** reduces the timer delay, with **MANUAL** coming below the 1 minute mark.
3. When you have selected the delay you desire, simply allow the N°31.5 to “time-out” and revert to a normal display.

The N°31.5 will display **AUTO STANDBY** for about one second prior to actually going into standby as a result of the auto standby setting you have chosen.

Madrigal Communications Link

The information needed to take full advantage of the Madrigal Communications Linking system (MCL) falls into two categories: understanding the architecture used, and summarizing which cables are needed between which components. The following technical information is provided as a reference, for custom installations and other applications where a full understanding of the MCL system is important. Most people never need this information. Feel free to skip this section unless the basic information in *Rear Panel* is not sufficient to your needs.

Understanding the Architecture

The MCL system is a single-master computer bus. As such, there must be a single “master” component that acts as the central clearinghouse for all messages. Think of the master component as being like the Post Office: if the N^o31.5 needs to send a message to the N^o38S preamplifier (for example), it sends the message to the master component, which then relays it to the preamplifier. In our system (for a variety of technical reasons), the digital audio processor is normally designated as the “master” for the entire chain of line-level components. (We’ll address power amplifiers in a moment.)

This approach offers several advantages: it is quite robust and reliable; it responds *extremely* quickly (fast enough to seem instantaneous to the user); many components may be added to the system without taking a performance hit; it offers excellent forward compatibility, leaving options open to add new features and capabilities as they become needed.

A system such as this operates with the “master” at one end of a “daisy chain.” Subsequent components are linked together via **slave in** and **slave out** ports. Thus, one would begin at (say) a N^o30.5, going from its **master** port to (say) a N^o31.5’s **slave in** port; from the N^o31.5’s **slave out**, continue through as many **slave in/slave out** ports as needed, until you reach the preamplifier.

In this fashion, multiple digital transports may be easily accommodated. The digital processor will identify which transport is connected to which digital input by asking each in turn to momentarily turn off its DAS (digital audio signal), then noting which input is affected. In this way, a single master can easily identify several identical transports and still avoid any confusion. (This identification process is called “handshaking.”)

The Mark Levinson preamplifier (N^o38 or N^o38S) serves to *terminate* the communications bus. Hence, it receives communications from other line-level components via its **slave** port. It does not have a **slave out** (since it terminates the bus, it *must* be at the end). Since there is no way for the digital processor to perform the digital “handshake” described above, ***you must rename the inputs of the N^o38 or N^o38S appropriately*** (as outlined in the manual) for Linking to operate correctly.

Thus, for example, when the N^o31.5 is turned on, the N^o30.5 comes out of standby and selects the correct digital input, and instructs the N^o38S to wake up and select *whichever input is named* “No30.” (The N^o38S may further instruct the N^o333 to come out of standby.)

“Linked amplifiers?” you ask

The communication required between preamplifier and power amplifier(s) is more limited than between other components. In particular, the new 300 series Mark Levinson amplifiers will:

- toggle between **standby** and **operate** in conjunction with the N°38(S) they are Linked to;
- when in **standby**, all of the standby indicator LEDs (sources, preamp and power amps) blink in sync with one another;
- report certain fault conditions to the preamplifier if they must shut down for some reason.

For this reason, it made sense to define a somewhat simpler communications Link between preamps and power amps. In this case, the N°38 or N°38S acts as the “master” to the power amplifier(s) “slave.” Multiple amps may be daisy-chained via their **slave in** and **slave out** ports. The N°38 runs this smaller “network” and passes necessary information back and forth as needed.

Hence, our seemingly confusing nomenclature on the rear panels of the various products. “Master” is connected to “Slave In”, then the daisy-chain continues to Slave Out, to Slave In, to Slave Out, etc., until you reach the preamplifier’s Slave In. From there, you connect the N°38’s Master to the power amp’s Slave In. If you have more than one amp in the system, daisy chain them Slave Out to Slave In (up to a maximum of six amplifiers). (See sample diagram below.)

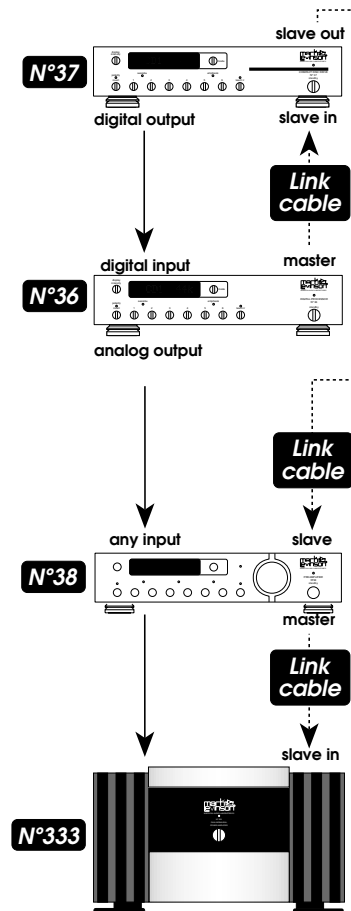

Which Cables Go Where?

Having cleared up (we hope) the conceptual difficulty with how Linking works and with the names of the various Link communications ports, we move on to the purely pragmatic: what size cables do I use? Where?

The Link system uses standard telephone company modular connectors, similar to the ones used in your telephone or computer modem. **All communications cables through to the preamplifier use an eight-conductor flat cable with an eight-pin modular plug (RJ-45) at each end.** These cables are made “straight-through,” the same way the phone company uses them: Pin #1 at one end is connected to Pin #1 at the other end, #2 to #2, etc. The Pins are numbered from left to right as seen from the “pin” side of the modular plug, as shown below.

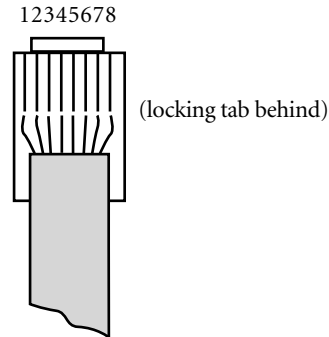

Counter-intuitively, you must insert a 180° twist in the wire to build this “straight-through” cable (since the plugs are pointing in opposite directions), as shown below:

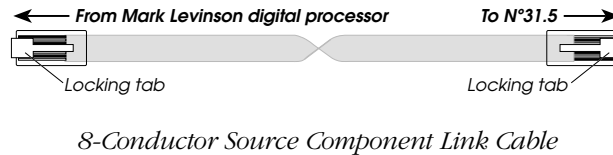

The Link between the preamplifier and the first power amplifier is different: it uses a six-conductor version of the same idea, as shown below:

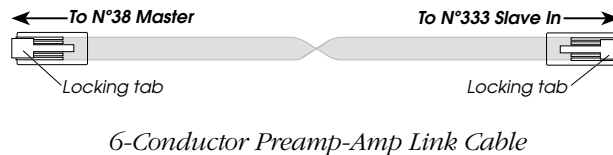

If you have more than one power amplifier in the system, it is important to ensure that the daisy-chain is preserved: **slave out** to **slave in**, **out** to **in**, etc.

To minimize the chance of accidentally plugging a **slave out** to a **slave out** (which would damage the communications circuits), we use different sizes of modular connectors at each end of the power amp daisy chain. We are still using only six connections and therefore six conductors, but we have placed an **eight-pin** connector at the **slave out** end of the cable, as shown below:

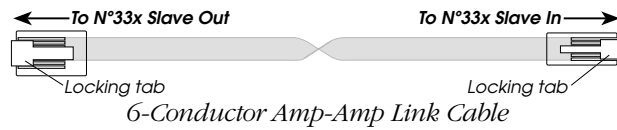

In this case, we use pins 1-6 of the eight-pin connector in a “straight-through” connection, and leave pins 7-8 empty.

Using the latest software

As we add features and functionality to the Link system, we sometimes need to update associated software. If you are Linking a system with one or more older components (early N°38's, N°30, N°31, etc.), you may need to have your dealer replace a socketed EPROM in order to install the current version of that product's software. If you think you may need new software, please contact your dealer *with the software code numbers of all N°30 Series units in the system*. This information is typically shown during power-up as the word CODE followed by a combination of four numbers and/or letter. (Your dealer should be able to help you with this.)

Using Learning Remote Controls

The N°31.5 includes both an infrared receiver *and* an infrared transmitter. With this capability, it can “teach” a learning remote control any commands that might be needed for remote operation that do not exist on the remote control itself.

Specifically, the N°31.5 can send these additional IR commands from its **display** window, enabling you to teach a learning remote any or all of its front- (or top-) panel commands, as well as some optional special commands that are available to solve specific installation-related problems.

The N°31.5 has two special modes of operation into which it may be placed in order to facilitate the “teaching” of remote control commands to a learning remote control. The first allows you to easily teach the commands for which there are corresponding front panel buttons. The second allows you to teach “special” commands to the remote control for which there are no corresponding front panel buttons.

Teaching N°31.5 Front Panel Commands

1 PRESS AND HOLD THE REPEAT DISC BUTTON TO ENTER THE FRONT PANEL TEACHING MODE

The display will show **TEACH IR** to indicate that the N°31.5 is ready to teach a learning remote control the infrared commands that correspond to its front- and top-panel buttons.

If you change your mind, simply don't touch *any* button for ten seconds and the N°31.5 will return to normal operation. (*Hint:* you may remember that this special “hidden” feature of the N°31.5 is accessed via a press-and-hold of the **repeat disc** button by associating its use with the external IR “repeaters” so often used in custom installations; the functionality found here is of most value in such installations.)

2 PRESS ANY FRONT- OR TOP-PANEL BUTTON TO CAUSE THE N°31.5 TO SEND THE CORRESPONDING IR COMMAND

Line up the IR window of your remote control with the right side of the N°31.5 display (to the right of where seconds normally display), at a distance of approximately 2"-6". Select the to-be-learned button on the remote, then press the corresponding button on the N°31.5 to fire the appropriate IR code. The display will change to indicate the sending of the IR signal: **sending code**. When it reverts to **TEACH IR**, it is ready to issue the next command to be learned.

Most learning remotes need to be held fairly still while they learn new IR commands; movement can garble the received IR. If you are uncertain as to how to prepare your remote control for learning new commands, refer to the instructions provided with the remote control.

Teaching Other N°31.5 Commands

3 REPEAT THE PROCESS OF “TEACHING” NEW COMMANDS TO THE VARIOUS BUTTONS ON YOUR REMOTE CONTROL UNTIL ALL APPROPRIATE OR DESIRED FRONT PANEL COMMANDS HAVE BEEN LEARNED BY YOUR REMOTE

4 WHEN FINISHED, EXIT THE TEACH IR MODE BY ALLOWING THE N°31.5 TO “TIMEOUT”

You may wish to teach your remote control some of the N°31.5's special commands (those for which there is no corresponding panel button); in this case, you should go directly to the next section. Otherwise, simply avoid pressing any buttons for about ten seconds, and the N°31.5 will automatically return to normal operation.

At some point, however, you should test all your newly “learned” commands to ensure that they were “learned” correctly.

As mentioned above, the N°31.5 has the capability to teach learning remote controls special commands for which there are no front panel counterparts. These commands can be especially helpful in solving problems in certain kinds of custom installations.

These “positive control” commands in the N°31.5 will place it into a certain mode of operation regardless of its current state. For example, a positive control command to enter **standby** will *leave* the N°31.5 in **standby** if already there, or *switch* it to **standby** if it is currently operating. This type of positive control is especially helpful when you do not necessarily know the current status of the N°31.5, as might be the case in a multi-room home entertainment system (for example).

1 PLACE THE N°31.5 IN ITS FRONT PANEL TEACHING MODE

As explained on the previous page, you do this by pressing and holding the **repeat disc** button until the display reads **TEACH IR**. If no further buttons are pressed within approximately ten seconds, the N°31.5 will “time out” and return to normal operation.

2 RELEASE, THEN PRESS AND HOLD THE REPEAT DISC BUTTON A SECOND TIME TO PLACE THE N°31.5 IN ITS CUSTOM IR MODE

After about five seconds, the display will change from **TEACH IR** to **IR CODE 01**. This indicates that the special IR codes that do not correspond to front-panel buttons are now available for teaching to a learning remote control—including some that are designed to solve problems unique to custom installations.

3 PRESS THE REPEAT DISC BUTTON REPEATEDLY TO ADVANCE TO THE DESIRED FUNCTION

The table on the next page lists the various commands that are available for the N°31.5 for which there is no front-panel equivalent. In some cases, they represent “positive control” alternatives to commands which normally toggle between two settings (such as standby and operate). In other cases, they represent functions which exist only on the remote control. In the second column are the designations that will be displayed to indicate that the N°31.5 is ready to fire the corresponding IR code.

Pressing **repeat disc** will advance you to the next command in the table; when you reach the end of the list, the №31.5 will return to the beginning. If no button is pushed for more than ten seconds, the №31.5 will “time out” and return to normal operation.

Command	Display
positive “operate”	OPERATE
positive “standby”	STANDBY
positive “stop w/o moving lid”	STOP, NO LID
positive “display intensity to off”	DISPLAY OFF
positive “display intensity to medium”	DISPLAY MED
positive “leave pause”	UNPAUSE
positive “enter pause”	PAUSE
positive “turn off repeat”	REPEAT OFF
positive “turn on index mode”	INDEX ON
positive “turn off index mode”	INDEX OFF
positive “open lid”	OPEN LID
positive “close lid”	CLOSE LID
single-button “random play”	RANDOM PLAY
switch to analog-input switching mode	ANALOG MODE
switch to digital-input switching mode	DIGITAL MODE

4 MOMENTARILY PRESS THE DISPLAY INTENSITY BUTTON TO TRANSMIT THE SELECTED IR CODE

Line up the IR window of your remote control with the right side of the display of the №31.5, at a distance of approximately 2"-6". Select the to-be-learned button on the remote, then fire the selected code from the №31.5 by pressing **display intensity**. The №31.5’s display will show **sending code** during the IR transmission.

(If you are uncertain as to how to prepare your remote control for learning new commands, refer to the instructions provided with the remote control.)

5 REPEAT THE PROCESS OF “TEACHING” NEW SPECIAL COMMANDS UNTIL ALL DESIRED COMMANDS HAVE BEEN LEARNED BY YOUR REMOTE CONTROL.

If you take longer than approximately ten seconds between button pushes, the №31.5 will time out and return to normal operation. If this occurs, return to step #1 in this section. You may cycle through the entire list by pressing **repeat disc** repeatedly.

6 WHEN FINISHED, RETURN TO NORMAL OPERATION BY ALLOWING THE №31.5 TO “TIME OUT”

The №31.5 will “timeout” and return to normal operation after approximately ten seconds.

Troubleshooting

In general, refer any service problems to your Mark Levinson dealer. Before contacting your dealer, however, check to see if the problem is listed here. If it is, try the suggested solutions. If none of these solves the problem, contact your Mark Levinson dealer.

1. THE N°31.5 WON'T FUNCTION, AND THE DISPLAY IS DARK.

- ✓ The unit is in standby. Press the **standby** button.
- ✓ The N°31.5 isn't plugged into the AC mains or the main power switch isn't turned on.
- ✓ The wall socket, adapter, or extension cord is faulty.
- ✓ There's a tripped circuit breaker or blown fuse in the wall outlet's circuit.
- ✓ A fuse is blown in your N°31.5 (contact your Mark Levinson dealer).

2. THE DISPLAY IS LIT, BUT THERE IS NO OUTPUT

- ✓ The proper source isn't selected on your digital processor.
- ✓ The proper source isn't selected on your preamplifier.
- ✓ The interconnecting cables are connected incorrectly or are faulty.

3. THE N°31.5 DISPLAY READS "NO DISC"

- ✓ There is no disc in the drawer for the transport to read.
- ✓ The disc is upside down and therefore cannot be read.
- ✓ The disc has loaded improperly and cannot be read—open the drawer, ensure that the disc is placed properly in the drawer, and try again.

4. THE N°31.5 DISPLAY READS "NO DAMPER"

- ✓ There is no damper in the transport well; reopen the lid and place the damper on the disc.
- ✓ The damper is incorrectly positioned; center it on the CD spindle.
- ✓ The lid was interrupted before it could close, and therefore could not sense the damper's presence; remove the obstruction and allow the lid to close.

5. THE N°31.5 WON'T PLAY A CD INSERTED IN THE PLAYER.

- ✓ The CD is inserted upside down. Be sure to insert it shiny side down (label side up).
- ✓ There may be condensation (moisture) on the laser pickup. This can happen if the N°31.5 is moved from a cold environment (such as a warehouse or a shipper's truck) to a warm, humid one. Set the **main power** switch to its "I" position, and leave it on for at least one hour to warm up, then try playing a CD again.

6. WHEN A CD IS PLAYING, THE SOUND "SKIPS."

- ✓ The CD is severely scratched or dirty.
- ✓ The N°31.5 is on an unstable surface or is too close to your speakers.

6. THE LINKED FUNCTIONS DON'T WORK.

- ✓ Try to **SET OPTIONS** (press and hold **display mode**). Once you have **SET OPTIONS** in the display, click on **display mode** a couple times. If the display never advances beyond **INDEX 0**, then your Link connection is not active. Check your Link cables.
- ✓ There is no “master” on the Link system: a Mark Levinson digital processor normally serves as central clearinghouse of information being passed from one component to the next. Without it, the Linking system cannot work.
- ✓ The digital audio cable is disconnected, or is connected incorrectly (in which case the **display link** function would continue to work correctly, but many others would not work).
- ✓ Try turning off/disconnecting AC power from both the processor and the N°31.5. After several seconds, restore AC power to the digital processor, *then* turn on the N°31.5's **main power** switch.
- ✓ You may have older versions of the system software in your associated Mark Levinson components which do not fully support all Setting Options.

Mark Levinson components normally display a “code” number when powering up that corresponds to the version number of their software. (*On the N°31.5, you can also display this number by pressing and holding the **stop** button.*) Write down the code number for each component. With this information, your dealer can determine whether you need to update some software in your system. If so, new EPROMs will be provided at no charge.

7. THE REMOTE CONTROL DOESN'T OPERATE THE N°31.5.

- ✓ The Remote Control is at the wrong angle relative to the N°31.5, and the N°31.5 can't receive the signal.
- ✓ The sensor window on the front panel of the N°31.5 is dirty or blocked.
- ✓ The Remote Control's projection lens is dirty.
- ✓ Fluorescent lighting or sunlight is interfering with the operation of the Remote Control.
- ✓ The Remote Control's batteries are weak and need to be replaced.
- ✓ The Remote Control's batteries are installed incorrectly.

Care and Maintenance

To remove dust from the cabinet of the N°31.5, use a feather duster. To remove dirt and fingerprints, we recommend isopropyl alcohol and a soft cloth.

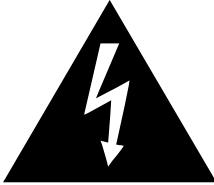

Caution!

Always apply the isopropyl alcohol to the soft cloth and then wipe the N°31.5 with the dampened cloth. Never pour or spray even small amounts of any liquid directly on the N°31.5, as doing so may allow the liquid to reach the circuitry inside the unit. Any liquid inside the unit poses a hazard to both the user and to the unit, and must be avoided.

Make sure that the Remote sensor window on the front panel and the Remote Control's projection lens are kept clean and dust-free.

Fluorescent lighting and sunlight may interfere with the operation of the Remote Control. Avoid placing the N°31.5 near fluorescent lamps or in direct sunlight.

When the Remote Control's batteries need to be replaced, use only AA batteries; always replace both batteries at the same time. If you don't plan to use the Remote Control often, remove the batteries. When not used for an extended period, even "leakproof" batteries can leak corrosive acids that will damage the Remote Control (and will void the warranty).

A CD, handled carefully, will last indefinitely. A warped, dusty, or scratched CD can cause playback problems, including audible skipping or other noises. Handle a CD by the outer edges only; if necessary, support it with your index finger at the center hole.

When you're finished playing a CD, always return it to its plastic case. Store your CDs where they won't be exposed to direct sunlight, high humidity, or extremely high or low temperatures.

U.S. and Canadian Warranty

90-Day Limited Warranty

This Mark Levinson® product is warranted to be free from defects in material and workmanship under normal use for a period of ninety (90) days from the date of purchase. **To extend the warranty of this Mark Levinson product**, return the warranty registration card along with a copy of the original receipt of purchase to Madrigal Audio Laboratories, Inc., P. O. Box 781, Middletown, CT 06457.

Five Year Extended Warranty

The **extended warranty** for this Mark Levinson product is **five (5) years** from the date of purchase. During the warranty period, any Mark Levinson component exhibiting defects in materials and/or workmanship will be repaired or replaced, at our option, without charge for either parts or labor, at our factory. The warranty will not apply to any Mark Levinson component that has been misused, abused or altered.

Any Mark Levinson component not performing satisfactorily may be returned to the factory for evaluation. Return authorization must first be obtained by either calling or writing the factory prior to shipping the component. The factory will pay for return shipping charges only in the event that the component is found to be defective as above mentioned. There are other stipulations that may apply to shipping charges.

There is no other express warranty on this component. Neither this warranty nor any other warranty, express or implied, including any implied warranties of merchantability or fitness, shall extend beyond the warranty period. No responsibility is assumed for any incidental or consequential damages. Some states do not allow limitations on how long an implied warranty lasts and other states do not allow the exclusion or limitation of incidental or consequential damages, so that the above limitation or exclusion may not apply to you.

This warranty gives you specific legal rights, and you may also have other rights which vary from state to state. **This warranty is applicable in the United States and Canada only.** Outside of the U.S. and Canada, please contact your local, authorized Mark Levinson distributor for warranty and service information.

Obtaining Service

We take great pride in our dealers. Experience, dedication, and integrity make these professionals ideally suited to assist with our customers' service needs.

If your Mark Levinson component must be serviced, please contact your dealer. Your dealer will then decide whether the problem can be remedied locally, or whether to contact Madrigal for further service information or parts, or to obtain a Return Authorization. The Madrigal Technical Services Department works closely with your dealer to solve your service needs expediently.



Important!

Return authorization must be obtained from Madrigal's Technical Services Department BEFORE a unit is shipped for service.

It is extremely important that information about a problem be explicit and complete. A specific, comprehensive description of the problem helps your dealer and the Madrigal Technical Services Department locate and repair the difficulty as quickly as possible.

A copy of the original bill of sale will serve to verify warranty status. Please include it with the unit when it is brought in for warranty service.



Warning!

All returned units must be properly packaged (preferably in their original packing material), and the proper return authorization numbers must be marked on the outer carton for identification. If the packaging to protect the unit is, in our opinion or that of our dealer, inadequate to protect the unit, we reserve the right to repackage it for return shipment at the owner's expense. Neither Madrigal nor your dealer can be responsible for shipping damage due to improper (that is, non-original) packaging.

Your dealer can order a new set of shipping materials for you if you need to ship your component and no longer have the original materials. There will be a charge for this service. We *strongly* recommend saving all packing materials in case you need to ship your unit some day.

Specifications

The correlation between published specifications and sonic quality is unreliable. A list of numbers reveals virtually nothing. All technical measurements must be subject to qualitative as well as quantitative interpretation.

Measurements of the N°31.5 yield excellent results by any standards. However, only those specifications that apply to its actual operation are included here.

- Direct digital output, XLR: AES/EBU 110Ω, 3.5V
- Direct digital output, RCA: S/PDIF 75Ω, 0.5V
- Direct digital output, ST: Hewlett-Packard® ST optical
- Direct digital output, EIAJ: Sharp® EIAJ optical
- Mains voltage: 100V, 120V, 200V, 220V, 240V,
factory set for destination country only
- Mains frequency: 50 or 60 Hz,
factory set for destination country only
- Power consumption: 36 watts maximum
- Overall dimensions: See Dimensions
- Shipping weight: 63 lbs. (28 kg)
- Connector complement:
 - 1 male XLR-type connector
 - 1 female RCA-type connector
 - 1 ST-type optical connector
 - 1 EIAJ-type optical connector
 - 2 RJ45 connectors
 - 1 IEC mains connector
(with built-in fuse holder)

Madrigal provides an owner-transferable, five year limited warranty on all Mark Levinson products within the U. S. and Canada ONLY. Warranty and service policies outside the U. S. and Canada are set by the local, authorized distributor and are applicable in the country of purchase ONLY. Madrigal products are designed to operate at set voltages appropriate for the country of sale and may be damaged if operated at the wrong voltage.

Dimensions

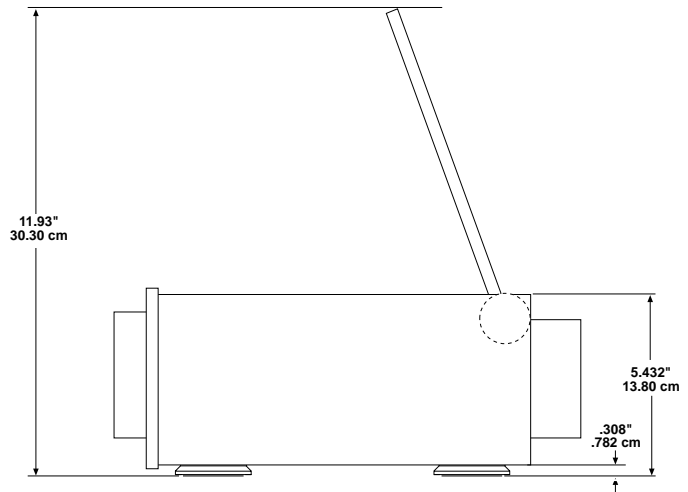
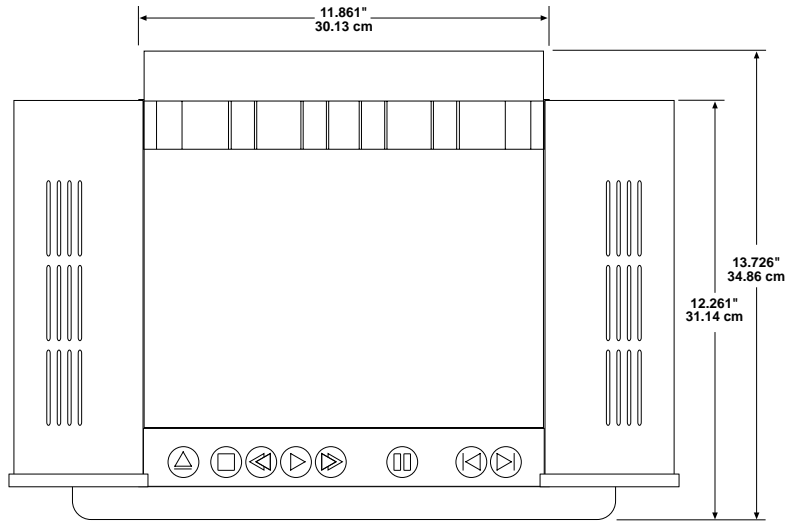
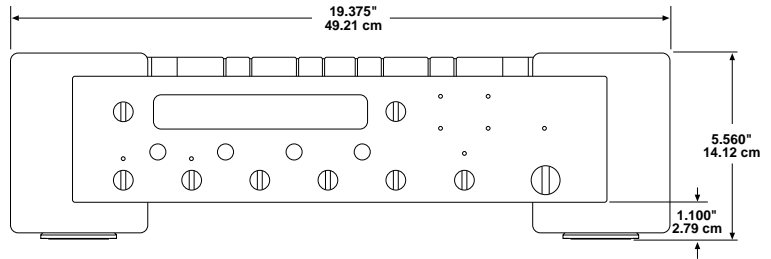



MADRIGAL

Madrigal Audio Laboratories, Inc.
2081 South Main Street, P.O. Box 781
Middletown, Connecticut 06457 USA

Telephone: (860) 346-0896
Fax: (860) 346-1540
<http://www.madrigal.com/>

**mark
levinson**[®]
MADRIGAL AUDIO LABORATORIES

is a registered trademark of Madrigal Audio Laboratories, Inc.

H a Harman International company