

Operating Manual

Mark Levinson®
N°37
CD Transport

Madrigal Audio Laboratories, Inc.

WARNING: TO REDUCE THE RISK OF FIRE OR ELECTRIC SHOCK, DO NOT EXPOSE THIS APPLIANCE TO RAIN OR MOISTURE.

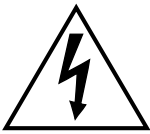
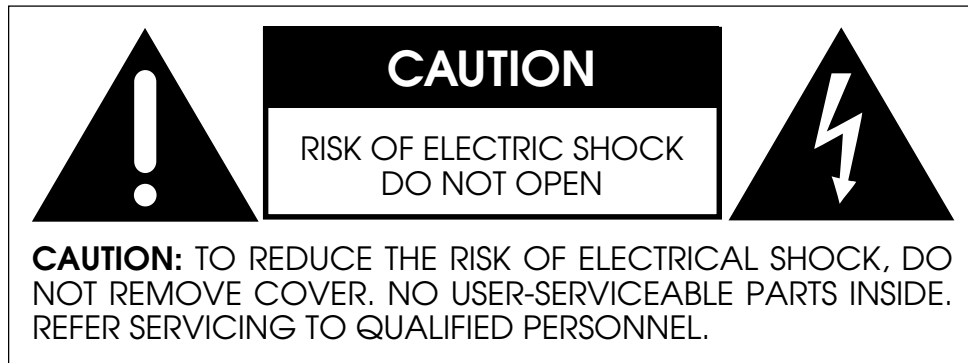

The lightning flash with arrowhead symbol, within an equilateral triangle, is intended to alert the user to the presence of uninsulated “dangerous voltage” within the product’s enclosure that may be of sufficient magnitude to constitute a risk of electric shock to persons.



The exclamation point within an equilateral triangle is intended to alert the user to the presence of important operating and maintenance (servicing) instructions in the literature accompanying the appliance.



Marking by the “CE” symbol (shown left) indicates compliance of this device with the EMC (Electromagnetic Compatibility) and LVD (Low Voltage Directive) standards of the European Community.

NOTICE

This equipment has been tested and found to comply with the limits for a Class B digital device, pursuant to Part 15 of the FCC Rules. These limits are designed to provide reasonable protection against harmful interference in a residential installation. This equipment generates, uses and can radiate radio frequency energy and, if not installed and used in accordance with the instructions, may cause harmful interference to radio communications. However, there is no guarantee that interference will not occur in a particular installation. If this equipment does cause interference to radio or television reception, which can be determined by turning the equipment on and off, the user is encouraged to try to correct the interference by one or more of the following measures:

- Reorient or relocate the receiving antenna;
- Increase the separation between the equipment and the receiver;
- Connect the equipment into an outlet on a circuit different from that to which the receiver is connected;
- Consult the dealer or an experienced radio/TV technician for help.

CAUTION: Changes or modifications to this equipment not expressly approved by the manufacturer could void the user’s authority to operate the equipment.

The information contained in the manual is subject to change without notice. The most current version of this manual will be posted on our web site at <http://www.madrigal.com>.

Important Safety Instructions

Please read all instructions and precautions carefully and completely before operating your Mark Levinson component.

1. **ALWAYS** disconnect your entire system from the AC mains before connecting or disconnecting any cables, or when cleaning any component.
2. This product is equipped with a three-conductor AC mains power cord which includes an earth ground connection. To prevent shock hazard, all three connections must **ALWAYS** be used. If your electrical outlets will not accept this type of plug, an adapter may be purchased. If an adapter is necessary, be sure it is an approved type and is used properly, supplying an earth ground. If you are not sure of the integrity of your home electrical system, contact a licensed electrician for assistance.
3. **ALWAYS** keep electrical equipment out of the reach of children.
4. AC extension cords are not recommended for use with this product. If an extension cord must be used, be sure it is an approved type and has sufficient current-carrying capacity to power this product.
5. **NEVER** use flammable or combustible chemicals for cleaning audio components.
6. **NEVER** operate this product with any covers removed.
7. **NEVER** wet the inside of this product with any liquid.
8. **NEVER** pour or spill liquids directly onto this unit.
9. **NEVER** block air flow through ventilation slots or heatsinks.
10. **NEVER** bypass any fuse.
11. **NEVER** replace any fuse with a value or type other than those specified.
12. **NEVER** attempt to repair this product. If a problem occurs, contact your Mark Levinson® dealer.
13. **NEVER** expose this product to extremely high or low temperatures.
14. **NEVER** operate this product in an explosive atmosphere.
15. **ALWAYS** unplug sensitive electronic equipment during lightning storms.

Table of Contents

Unpacking and Placement	6
Unpacking the N°37	6
Remove the Transport Screws	6
Placement of the N°37	6
Operating Voltage & Frequency	7
<i>Voltage label</i>	7
A Quick Start.....	8
Warm up/break-in period	9
Special Design Features.....	10
A New Generation	10
Digital Servo Control	10
Output Versatility	10
Industrial Design	11
Convenience Features	11
Communications Links	11
Front Panel, N°37	12
Playing "Index 0"	16
the extended pause mode	16
Auto Standby	17
Display Messages, N°37	18
Rear Panel, N°37	20
<i>AC power cord polarity</i>	20
<i>Linking connections</i>	21
<i>Building link cables</i>	22
<i>IR input tip polarity</i>	22
Remote Control, N°37	24
Random Play	25
Analog Input Switching	27
Conditions that Affect IR Performance	27
<i>Optimum IR reception window</i>	28
Setup and Installation	29
Connecting AC Mains	29
Making Digital Audio Connections	29
Making Link Connections	29
Basic Operation	30
Loading a CD	30
Playing a CD	30
Random Play	30
Navigating the Disc	30
Direct Time Access	31
Pause	31
Repeat Disc	32
Repeat Track	32
A-B Repeat	32
Polarity	32
Playing "Index 0"	32

Programming the N°37	33
Introduction to Playlists	33
Assembling a Playlist	34
Programming by Omission	34
Saving a Playlist	34
Reviewing a Playlist	34
Deleting a Track from a Playlist	35
Adding a Track to a Playlist	35
Overriding a Playlist	35
Erasing Playlists from Memory	35
Why Polarity Programming?	36
Whole-Disc Polarity Programming	36
Track-by-Track Polarity Programming	37
Linked Functions	38
Standby link	38
Name link	38
Play link	38
Display Link	38
Polarity link	38
Changing Link Options	39
Auto-Standby	39
Using Learning Remote Controls	40
Teaching N°37 Front Panel Commands	40
Teaching Other N°37 Commands	41
<i>special commands table</i>	42
Troubleshooting	44
Care and Maintenance	46
U.S. and Canadian Warranty	47
Limited five year warranty	47
Obtaining Service	48
Specifications	49
Dimensions	50
Installation Notes	51

Unpacking and Placement

Unpacking the N°37

Unpack your N°37 CD Transport and remove all accessories from the carton.



Important!

Keep all packing materials for future transport of your N°37. Shipping your new component in anything other than its purpose-designed packing material may result in damage that is not covered by the warranty.

Included with your new Mark Levinson product is a pair of knit, white gloves designed to assist you in the initial unpacking and placement of your new purchase. Please accept them as a token of our appreciation for having purchased one of our products.

Remove the Transport Screws

Place the N°37 CD Transport upside-down on a soft, clean surface. Remove the transport screws from the bottom of the unit and save them with the packing materials for future use.



Warning!

The transport screws must be removed before operating the N°37, since they immobilize the transport mechanism during shipping to prevent damage. These screws must also be replaced before shipping the unit.

Placement of the N°37

The N°37 should be placed close to your digital audio processor, thus keeping interconnect cabling reasonably short. It may be placed on a shelf or in a cabinet where it is convenient to operate, but should not be rack mounted, so as to leave access to the rear panel power switch.

The N°37 is designed for continuous operation—hence the standby button on the front panel rather than a power button. However, a rear-panel power switch is provided for your convenience should you want to disconnect the unit from the AC mains (as when taking a vacation, for example).

Be sure to allow 3 to 4 inches of clearance above the N°37 to allow heat dissipation through air circulation.

Drawings are included in this manual to facilitate special installations and custom cabinetry (see *Dimensions*).

Operating Voltage & Frequency

The N°37 CD Transport is set at the factory (internally) for 100V, 120V, 200V, 220V, or 240V AC mains operation as appropriate for the country in which it is to be sold. Make sure that the label on the rear of the N°37 (adjacent to the power cord) indicates the correct AC operating voltage for your location, as attempting to operate the N°37 at an incorrect voltage can damage the unit. *(Note that only 230V units are sold in the European Union countries, per CE requirements.)*

The N°37 CD Transport is also set at the factory for operation on either 50 or 60 Hz AC line frequencies, as appropriate for the country in which it is to be sold. It will not operate if it senses an incorrect line frequency.

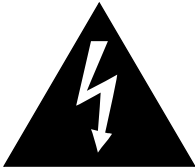

Warning!

Neither the voltage nor the line frequency setting may be changed by the user. There are no user serviceable parts inside the N°37. Only qualified, authorized service personnel may open the N°37 CD Transport, as hazardous voltages exist within the unit.

If the AC mains voltage or frequency indicated on your N°37 is incorrect, please contact your local, authorized Mark Levinson dealer or distributor.

The N°37 can easily be powered by a normal 15-ampere AC mains line. If other devices are also powered from the same AC line, their additional power consumption should be taken into account.

A Quick Start...

We recognize that many people are understandably eager to begin listening to their new components, and that reading the manual is often done (if at all) at a later time—perhaps while listening to music with the new product itself. We *strongly* recommend that you read this manual thoroughly, as the N°37 CD Transport incorporates many unusual features that enhance its operation.

Fortunately, we can help you get some music up and running on your system quickly, so that you may begin enjoying your new CD transport while reading more about it. The goal here is simply to make some music as quickly as possible. The following procedure assumes that the rest of your system is already connected (e.g., digital processor to preamplifier, to power amplifier, to speakers, etc.).

1 TURN OFF YOUR ASSOCIATED COMPONENTS

This minimizes the opportunity for a momentary electrical surge disturbing your system while making connections. If you have a large power amplifier, allow its power supply to fully discharge before proceeding (which may take as long as several minutes, depending on its design).

2 REMOVE THE TRANSPORT SCREWS FROM THE BOTTOM OF THE N°37

If you have not done so already, remove the slotted transport screws from the bottom of the N°37 now. Be sure to save them and all packing material for possible future use. (*Shipping the N°37 without proper packing material and without the transport screws in their proper positions may cause damage to the unit that would not be covered by the warranty.*)

3 CONNECT THE N°37 TO AC POWER

Connect the AC cord to the N°37 at the receptacle on the rear panel, and then to your AC outlet. Then turn on the power switch just above the AC power receptacle. (The international symbol for “on” is a single vertical line: |. “Off” is symbolized by a circle: O.) The N°37 will take a few moments to initialize and will then be ready to use.

4 CONNECT A DIGITAL OUTPUT TO A MATCHING DIGITAL INPUT ON YOUR PROCESSOR

The N°37 supports a variety of types of digital outputs to ensure compatibility with any digital processor you might wish to use. These digital outputs are found on the rear of the N°37. Madrigal has found that, *when fully optimized at both ends*, the AES/EBU professional digital interconnection standard is the finest available. Depending on your processor, however, you may find that a different interface is best in your system. It is important to use high quality digital cable such as Madrigal MDC-1 for AES/EBU (via XLRs), or MDC-2 for S/PDIF (via RCA or BNC) connections.

5 POWER UP THE REST OF THE SYSTEM, LEAVING THE POWER AMPLIFIERS FOR LAST

Always turn the power amplifier(s) off first, and on last. This good habit minimizes the opportunity for unexpected transients to be passed to your loudspeakers.

6 SELECT THE INPUTS YOU ARE USING ON YOUR DIGITAL PROCESSOR AND PREAMPLIFIER

Take care that a Tape Monitor switch does not override your selection of the digital processor's input on your preamplifier, or you will be struck by how "quiet" your new digital source is...

7 LOAD A DISC IN THE DRAWER AND PRESS PLAY; SLOWLY RAISE THE VOLUME ON YOUR PREAMPLIFIER

Congratulations! You should now be able to enjoy your favorite music while reading the rest of this manual. (Please, do read the rest of this manual.)

Warm up/break-in period

Although your Mark Levinson N°37 CD Transport delivers outstanding performance straight out of the box, you should expect to hear it continue to improve as it reaches its normal operating temperatures and its various components "break-in." It has been our experience that the greatest changes occur within the first few hours as the N°37 reaches thermal equilibrium. Depending on how cold the N°37 was when you first connected it to AC power, full thermal equilibrium might take as long as a day or two, after which time its performance will remain quite constant.

The only exception to this rule is if power is removed from the unit for more than a few minutes, allowing it to cool down. Depending on the degree of cooling involved, you should expect a brief warm-up period before the N°37's sound quality is at its best. Unless your N°37 was allowed to become quite chilled, subsequent thermal re-stabilization should not take long.

Special Design Features

Congratulations on your purchase of the N°37 CD Transport. The Madrigal design team is confident you will enjoy the outstanding performance of the N°37 for many years. In case you are interested in technical details, what follows is a brief outline of some of the key technologies in your new transport.

A New Generation

The characteristics of an outstanding CD transport are simple to define: it must recover the correct data from the disc, and deliver it to the digital processor without any timing errors (sometimes called “jitter”). As simple as this sounds, achieving it in reality has been extremely difficult—as evidenced by the significant sonic differences between various CD transports.

Conventional CD transport design depends on the quality of the oscillator used to control the rate at which the disc itself spins. This oscillator exists in an extremely “noisy” electrical environment close to the motor that spins the disc. The electrical noise introduces timing errors in the delivery of the digital signal that have come to be known as “jitter.” Subsequent handling of the digital audio signal in traditional transport designs cannot improve upon this “jittery” signal, lacking a better reference. To the contrary, the various stages of signal processing between the laser pickup and the final output can only contribute additional jitter of their own.

The Mark Levinson N°37 leaps beyond conventional digital audio technology by employing a proprietary, closed-loop jitter-reduction system in conjunction with a double speed CD-ROM drive. Using a custom-made crystal oscillator with better than five part-per-million accuracy, the digital signal is relocked immediately before the output, eliminating transport-related jitter from the digital audio signal. This same crystal oscillator controls the all-digital servo used to control the rate at which the disc spins.

In effect, the design of the N°37 turns the accepted *status quo* on its head. By placing the all-important reference clock in the *final* stage of the transport’s output section, and slaving the mechanical subassemblies to it rather than the other way around, the signal presented to the outputs of the N°37 is uncontaminated by electrically- or mechanically-induced jitter. The sonic advantages of this design are immediately apparent in the clarity, warmth and stunning dynamic contrasts exhibited by the N°37.

Digital Servo Control

The laser mechanism used in the N°37 uses all digital servo controls of its operations. Critical functions such as focus and tracking are handled completely in the digital domain with mathematical precision. Whereas conventional, analog servos require periodic realignments for optimum performance (to compensate for the aging of various analog components), a digital servo remains stable over time, never needing readjustment under normal conditions.

Output Versatility

All high quality digital output configurations are supported in the N°37. A new complementary driver for the balanced AES/EBU electrical output delivers outstanding performance to the high quality XLR connector. Single-ended S/PDIF electrical outputs are provided *via* both BNC and RCA connectors, and the ST

optical output uses a high-bandwidth Hewlett Packard® part for superior performance.

All digital interfaces have been carefully optimized to deliver the finest performance each interface standard allows. As a direct result, the N°37 performs optimally with any digital processor, without having to resort to techniques which would limit its compatibility to other Mark Levinson products.

Industrial Design

The N°37 shares the handsome industrial design of other Mark Levinson components such as the N°36 digital audio processor. The combination of the hand-brushed, black-anodized aluminum faceplate and bead-blasted custom-machined buttons make operating the N°37 a tactile as well as a sonic pleasure.

A large, easily read display provides information as to the operational status of the N°37 from across the room, making the supplied remote control more genuinely useful than on products lacking such a display.

In keeping with its sophisticated design, the N°37 also incorporates a Madrigal-designed loading mechanism. Contrasting strongly with the bulky, plastic drawers commonly used, the slim 1/8 inch drawer is machined from a solid piece of aluminum and rides on highly polished bearings. Its variable-speed design opens and closes quickly, but without jarring the disc contained within, nor risking a jam from dislodging it.

Convenience Features

Too often, high performance CD transports have eschewed convenience in the hopes of seeming more “performance-oriented.” While there were good arguments for such a “minimalist” design in the days of analog turntables, the time is long gone when the audiophile needed to give up operational convenience for musical performance. After all, convenience features in a digital product are largely a matter of writing appropriate software, and have no affect on the quality of the digital data itself.

The N°37 also supports custom programs, including “delete programming” wherein selected tracks are omitted from the playlist. This allows the user to skip the one or two songs on an otherwise good disc that have been overplayed *ad nauseam*. The N°37 will remember such programs for thousands of discs, should you want to save that many programs.

Communications Links

As with all Mark Levinson 30-series components, the N°37 incorporates a sophisticated inter-component communications bus. Unique among high performance audio systems, Mark Levinson 30-series components offer a degree of system integration that makes even complex systems easy to use.

For example, bringing the N°37 CD transport out of standby will also bring the Linked digital audio processor, preamplifier and power amplifier(s) out of standby, and select the appropriate inputs on both processor and preamplifier so that a CD can be enjoyed. Even a sophisticated system with any components can thus offer one-button simplicity of operation.

In short, the Mark Levinson N°37 establishes a new standard for performance and practicality among high end CD transports and should be auditioned by anyone who desires the finest in digital audio.

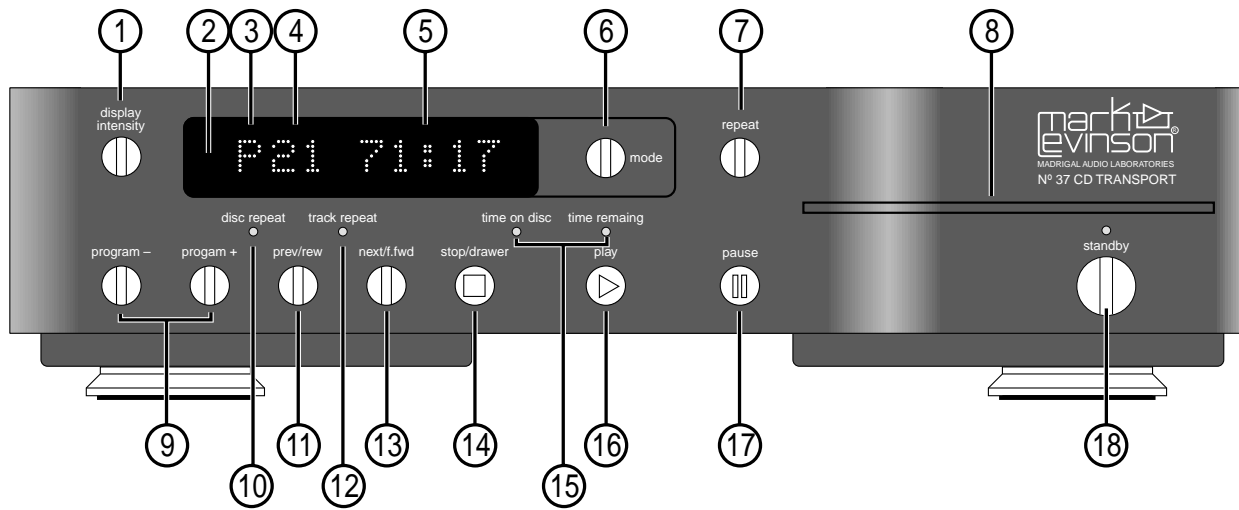

Front Panel, N°37

1 DISPLAY INTENSITY

Pressing this button varies the brightness of the **display**. Four brightness levels are available, including “display off.” All front panel LED’s change their brightness levels appropriately, except that they remain at the dimmest level when the display itself is off.

When power is first applied to the N°37 (or when power is restored after an interruption), the display is automatically set to its brightest level.

Pressing the **display intensity** button once dims the display one level; pressing it again dims it further; pressing it again turns the display off. Pressing **display intensity** once more returns the display to its brightest level. (If other Mark Levinson components in the system are “Linked” to the N°37, all display intensities can change in unison. See *Linked Functions* for more information.)

If the display is set to “off”, pressing any key will cause it to light at medium intensity for approximately four seconds in order to display the action of the key press.

2 INFRARED TRANSCIVER (WITHIN DISPLAY)

Infrared commands transmitted from the remote control are received by a receiver behind this section of the display. Remote control of the N°37 may be unreliable if there is not a clear line of sight between the remote control and the receiver (if the remote is far off-axis, or if the N°37 is within a cabinet, for example). In such a case consider using a third-party IR repeater to route the signal to the IR input jack on the rear panel (see *Rear Panel, N°37*, below).

In addition to receiving IR commands, the N°37 has the ability to teach a learning remote control its own commands from an IR transmitter located in this same area. (See *Using Learning Remote Controls* for more information.)

3 SPECIAL MODE INDICATOR

The first character in the display is reserved for indication of special modes of operation. For example, a **P** is displayed in this space to indicate a **Program** (a special sequence of tracks) is being played: **A** and **B** alternate while an **A-B loop** is being repeated.

4 TRACK INDICATOR

The next two characters are used to indicate the number of the track being played. When a compact disc is loaded but the transport is in the **stop** mode, this same space indicates the total number of tracks on the disc (or in the program for the current disc, if programmed).

5 TIME INDICATOR

The time section of the display can be set to display any of the following four indications of time in minutes and seconds: **time elapsed in track**, **time elapsed on disc**, **time remaining on disc**, **time remaining on track**. These four options are accessed by pressing the **mode** button to the right of the display (see 6, below), which cycles through the four modes of time display, using the **time on disc** and **time remaining** LEDs to indicate which mode is chosen at any moment. When in **stop**, the indicated time will always default to the total remaining time on the disc (or in the *playlist* for the current disc, if programmed). This time indication may be changed if desired once in **stop**.

6 MODE BUTTON

The **mode** button cycles through the four time display modes used to indicate where you are on the disc. These four display modes are:

- **time elapsed in track** (neither LED lit)
- **time elapsed on disc** (**time on disc** LED lit)
- **time remaining on disc** (**time on disc** and **time remaining** LEDs lit)
- **time remaining on track** (**time remaining** LED lit)

These four options are accessed by repeatedly pressing the mode button, which cycles through the four modes. In effect, the N°37 assumes you will be most interested seeing *elapsed time* on the *current track*; only departures from that assumption are denoted by LEDs. The N°37 will remember the last display mode selected and continue to display that information until you change it, except in **stop** (when it always defaults to showing the time remaining on disc, or in the disc's *playlist* if it has been programmed). If desired, once in **stop** the time indication may be changed to show any of the other display modes.

Along with **program +** and **program -**, the **mode** button is also used to change the link settings. (See *Linked Functions*.)

7 REPEAT BUTTON

You may choose to either repeat the entire disc (including any programs you might have entered for that particular disc) or an individual track by pressing the **repeat** button. From normal operation, the first press of the repeat button will cause the display to show **RPT DISC** momentarily, and subsequently will light the **disc repeat** LED below the display (number 10 in the front panel illustration). Pressing the **repeat** button again will display **RPT TRK** for a moment and then light the **track repeat** LED (number 12 in the front panel illustration). Pressing it a third time will cycle out of any repeating mode, as will pressing **stop/drawer** at any time. In either case, both repeat LEDs will be extinguished and the display will show **RPT OFF** for a few moments.

8 DRAWER

The N°37 employs an elegant, slim drawer that is machined from a solid piece of aluminum. It is normally opened and closed by pressing the **stop/drawer** button (number 14 in the front panel illustration). If opened, it may also be closed simply by gently pushing the front edge inward (as though you were going to close it manually). The N°37 will interpret this as a request to close the drawer and take over for you, smoothly closing the drawer.

If the N°37 senses an obstruction during opening of the drawer mechanism, it will attempt to re-close. If successful, it will read the disc's table of contents and display the disc's number of tracks and total time (followed by the playlist's track and time information, if one exists). If for any reason the drawer does not close fully, the display will show **DRAWER** to indicate the problem. After removing the obstruction, press the **stop/drawer** button again to close the drawer normally.

Similarly, if the N°37 senses an obstruction during the closing of its drawer (as might be caused by an improperly seated CD, or an inquisitive child's finger), it will stop immediately and attempt to reopen. If the nature of the obstruction prevents this also, it will stop where it is and wait for your intervention, displaying **DRAWER** to indicate the problem. After removing the obstruction, press the **stop/drawer** button again to close the drawer.

9 PROGRAM – AND PROGRAM + BUTTONS

Using these two buttons, the N°37 can be easily programmed to play a special “playlist,” or sequence of tracks, on any particular disc. Pressing **program +** adds a selection to a program.

Alternatively, it may simpler to omit the one or two songs that you have heard too many times on the radio, playing the rest of the tracks in order. Pressing **program –** will delete the selected track from the playlist, omitting it on playback.

A program may be entered any time a disc is in the N°37 and the unit is in the **stop** mode. For detailed information on programming the N°37, see *Programming the N°37* later in this manual.

10 DISC REPEAT LED

This LED is lit when the N°37 is set to repeat a disc (or a disc's program, if it has one) endlessly. This feature is accessed using the **repeat** button (see number 7, above).

11 PREV/REW BUTTON

Pressing this button *momentarily* will return you to the beginning of the **previous** track. *Pressing and holding* this button will instead perform a reduced-volume reverse scan of the music, reminiscent of the audible **rewind** function found on many cassette decks. This scanning mode allows you to quickly find a particular point within a track. (Incidentally, if you wish to listen to the *current* track over again from the beginning, simply press **play** while the track is playing.)

12 TRACK REPEAT LED

This LED is lit when the N°37 is set to repeat a single track endlessly. This feature is accessed using the **repeat** button (see number 7, above).

13 NEXT/F.FWD BUTTON

Pressing this button *momentarily* will advance the N°37 to the beginning of the **next** track. *Pressing and holding* this button will instead perform a reduced-volume fast forward scan of the music, reminiscent of the audible **fast forward** function found on many cassette decks. This scanning mode allows you to quickly find a particular point within a track.

14 STOP/DRAWER

Pressing this button once while a disc is playing will **stop** the disc, resulting in the total number of tracks and the total time on the disc being displayed. (Both the **time on disc** and the **time remaining** LEDs are lit to clarify the meaning of the information being displayed at this point.)

Pressing this button once the disc has stopped, or if there is no disc in the transport, will cause the **drawer** to open. If the disc is still playing, you may press the button twice rapidly, to effect both the **stop** command and the **drawer open** command; the N°37 will remember the second button push and execute it as soon as the disc has stopped spinning.

Pressing the **stop/drawer** button will cause an open drawer to close. If it senses a disc in the drawer, the N°37 will take a moment to read the disc's table of contents so that it may display the total number of tracks and the total time on the disc for your information. If a custom playlist exists for the disc, the total number of tracks and the total time of the playlist is displayed instead.

Finally, *pressing and holding* the **stop/drawer** button while the N°37 is stopped will display the version number of the operating software and its checksum. This "hidden feature" allows you to double-check the version number and integrity of the software in your unit without having to open it up, should this ever become necessary.

15 TIME ON DISC AND TIME REMAINING LED INDICATORS

These LEDs are used to indicate which of the four available display modes the N°37 is in. The four indications of time that can be displayed are:

- **time elapsed in track** (neither LED lit)
- **time elapsed on disc** (**time on disc** LED lit)
- **time remaining on disc** (**time on disc** *and* **time remaining** LEDs lit)
- **time remaining on track** (**time remaining** LED lit)

These four options are accessed by repeatedly pressing the **mode** button, which cycles through the four modes. If a custom playlist exists for the current disc, time elapsed or remaining “on disc” refers to the *playlist* rather than the entire disc.

16 PLAY BUTTON

As you might guess, press this button in order to **play** a disc. If a programmed sequence of tracks exists for that particular disc, the program will be played from its beginning. Also, as you might expect, you may press the **play** button immediately after placing a disc in the N°37’s drawer; the drawer will close and the N°37 will enter the play mode as soon as it has read the disc’s table of contents and checked to see if a program exists that ought to be played.

The **play** button has another important function: if you wish to return to the beginning of the track currently playing, simply press **play** to restart at the beginning of that same track. If the N°37 is in **pause**, pressing **play** will resume play.

Playing “Index 0”

A few CDs have recorded sounds in the space immediately preceding the songs themselves. This space is referred to as “Index 0” (as distinct from Index 1, which is where the track is normally thought of as “beginning.”) This is most common among live concert CDs, where you may hear some crowd noise before the each song begins. Some people find this audience noise distracting, and prefer to mute the inter-track output of the N°37 on those few discs where it exists. (From the factory, the N°37 is set to let you hear everything on the disc.)

To change whether or not Index 0 is audible, *press and hold* the **play** button for a few seconds, until the display reads **NDXØ OFF** or **NDXØ ON**. To toggle between on and off, click on the **play** button. When you have made your selection, press and hold the **play** button again until the display reads **SAVED**.

17 PAUSE BUTTON

Pressing this button once during play will **pause** the N°37 at that point within the track; the display will show double bars (||) as a reminder that you are in the **pause** mode.

the extended pause mode

After about two minutes in **pause**, the N°37 will go into an “extended pause” mode, showing **X-PAUSE** briefly in the display. **Extended pause** stops the disc and turns off the laser against the possibility that you have been called away and may not return for some time. The N°37 will slowly flash the double bars (||) to indicate that you are in the **extended pause** mode rather than normal **pause**.

You may force the N°37 into **extended pause** mode by *pressing and holding* the **pause** button (on either the front panel or the remote control) until the display shows **X-PAUSE**.

In effect, **extended pause** is much like **stop**, with the exception that pressing **play** will return you to the point on the disc where you had left off listening after only a momentary hesitation to spin the disc back up to speed and scan to the appropriate point. During this scan, the display will read **SCANNING**.

18 STANDBY & STANDBY LED

Assuming that the N°37 is connected to AC power and the **main power** switch on the rear panel is in the “I” position (see *Rear Panel, N°37*), pressing this button takes the N°37 out of **standby** mode and enables the front-panel controls.

When the N°37's **main power** switch is first turned on (or when power is restored after an interruption), the N°37 will be ready to operate (that is, it won't be in standby mode).

Pressing **standby** again places the N°37 into standby mode, which turns the **display** off, turns off all digital outputs, and disables the front-panel controls. The internal circuitry remains powered up in order to maintain its thermal stability and optimum performance at all times.

Pressing **standby**, **drawer**, or **play** will bring the N°37 out of standby, enabling the front panel controls, and activate the display and outputs.

While the N°37 is in standby, the LED above the **standby** button flashes approximately every five seconds. (When the N°37 is Linked to other Mark Levinson components, all their standby lights will blink in unison.) When the N°37 is ready to operate (that is, when it is not in standby mode), this LED remains lit continuously.

Auto Standby

As shipped from the factory, the N°37 will remain on until you deliberately place it in standby. If you prefer for it to automatically enter standby after a period of inactivity, press and hold the **standby** button until the display reads **MANUAL**. Subsequent clicks of the **standby** button will cycle it through **5 MIN**, **15 MIN**, **30 MIN**, and **60 MIN**. These options represent the length of time the N°37 must be inactive (no buttons pushed, no disc playing) before it will automatically go into standby. Having made your selection, press and hold the **standby** button again to confirm your change, until the display reads **SAVED**. You may change your N°37 back to manual standby mode at any time by reversing this process.

Note that **auto-standby** will place the N°37 into standby even if it is in **extended pause mode**, which will “lose your place” on the disc.

Display Messages, N°37

In addition to its normal task of displaying the track number and time, the display of the N°37 provides many helpful messages about current status and operations. Here are some of the messages you may see, and what they mean.

- **B < A:** You have specified an A-B loop in which the stopping point B is located *prior* to the starting point A; re-set your “B” point.
- **BAD DISC:** The N°37 senses the presence of a disc, but could not read important information on the CD; appears shortly after a disc is first inserted. Possible reasons include a badly damaged disc, one that is extremely dirty, or an upside-down disc.
- **CLOSING:** The drawer is in motion (closing); appears after the stop/drawer button is pressed.
- **DRAWER:** The drawer cannot open or close completely, such as when there is an obstruction.
- **DWR OPEN:** The drawer is fully open; appears after the stop/drawer button is pressed and the drawer has had time to open
- **END PGM:** The end of the existing playlist has been reached; appears after the next/f.wd button has been pressed repeatedly so as to reach the end of the current playlist (as when you review an existing program).
- **ERASING:** The existing program is being erased from permanent memory (in order to start with a clean list); appears after the **program –** button is pressed and held from within the **stop** mode.
- **FIRST:** The **previous** button was pressed while on the first track on the CD (or in a programmed playlist).
- **LAST:** The **next** button was pressed while on the last track on the CD (or in a programmed playlist).
- **LOCATING:** When asked to perform Linked functions such as Volume control or Mute (which are performed by a Linked Mark Levinson preamplifier), the N°37 may display LOCATING when first finding the preamp on the network. (This happens rarely, as it comes up only if the N°37 has temporarily lost contact with the preamp and is trying to re-establish communication.)
- **NO DISC:** There’s no disc in the N°37’s drawer, or something has prevented the N°37 from sensing a disc (such as an obstruction preventing the drawer from closing fully).
- **NO LINK:** Displayed if a Linked function is requested but cannot be completed due to a missing Link cable or component.
- **NO PGM:** There’s no program in the N°37’s memory; appears after **program +** (as when you try to review a nonexistent playlist) or **program –** (as when you temporarily override the current playlist) is pressed in the **stop** mode. It is also displayed when you individually delete all tracks from an existing playlist.
- **OPENING:** The drawer is in motion (opening); appears after the stop/drawer button is pressed.
- **PGM FULL:** The N°37 cannot accept additional tracks on the playlist for that particular disc (you may never see this—the upper limit is 99 entries per disc).

- **POWER-UP:** When AC power is first applied to the N°37, this message is displayed while the N°37 checks its circuitry and software to ensure proper operation.
- **RANDOM:** Shown momentarily when the N°37 has been placed into its **random play** mode (see p. 25).
- **READING:** The N°37 is reading the table of contents on the CD; appears when a disc is first inserted.
- **REVISED:** Changes in an existing playlist have been recorded in the N°37's permanent memory; appears when the **program +** button is pressed and held for a few seconds, after having edited the playlist.
- **RPT DISC:** The N°37 has entered the Repeat Disc mode, which will repeat the entire disc (or its playlist) endlessly, until it is asked to stop; this mode is activated by pressing the repeat button one or more times.
- **RPT TRK:** The N°37 has entered the Repeat Track mode, which will repeat the current track endlessly, until it is asked to stop; this mode is activated by pressing the repeat button one or more times.
- **SAVED:** New information was recorded in the N°37's memory; appears after the **program +** button is pressed and held to save a new playlist (for example), or to save new Link settings in permanent memory, or after changing the status of either Index 0 playback or Standby (manual or auto).
- **SCANNING:** The N°37 is leaving the Extended Pause mode, and is scanning for the point at which it will return to normal Play.
- **STANDBY:** The N°37 is going into standby, which will disable its front panel controls, mute its output, and turn off its display and its internal transport mechanism (including the laser). Critical circuitry remains on to remain at optimal operating temperatures, enhancing performance, reliability and longevity.
- **STOPPING:** The disc is being braked to a stop prior to the drawer opening.
- **TEACH IR:** Shown when entering the N°37's **teach ir** mode.
- **TRACK XX:** While the drawer is open, you may pre-select a track to be played upon pressing play. Under these circumstances, the display shows only **TRACK** and the number of the track you have pre-selected.
- **UNAVAIL:** You have tried to directly access a time or a track on the disc that does not exist (example, 4:58 into a 3:00 song, or the 13th track on a disc that only has 12 tracks). (Remember that times depend on the display mode you have selected, e.g., 5:55 when in the **time remaining on disc** mode means 5:55 from the end of the disc.)
- **X-PAUSE:** The N°37 has entered the Extended Pause mode, which turns off the laser and internal transport mechanism; pressing Play will spin up the disc and return you to where the unit went into Pause; this mode is activated by either leaving the N°37 in Pause for a few minutes, or by pressing and holding the Pause button.

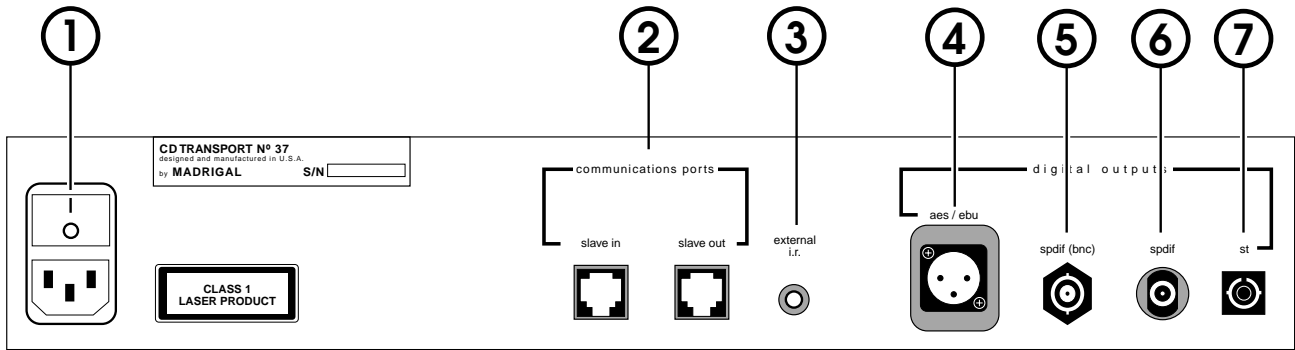

Rear Panel, N°37

1 AC POWER INPUT AND SWITCH

This input accepts AC power from the AC mains (via the supplied AC cable).

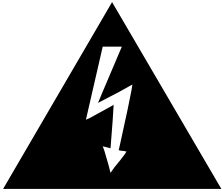

Warning!

The N°37 is set internally for 100, 120, 200, 220, or 240VAC mains operation at either 50 or 60Hz. Make sure that the label on the bottom of the unit indicates the correct AC operating voltage and frequency for your location before connecting it to AC mains.

Connect the female end of this cable to the N°37. Connect the male end of this cable to wall outlet or to an “unswitched” convenience outlet like those found on some audio components.

AC power cord polarity

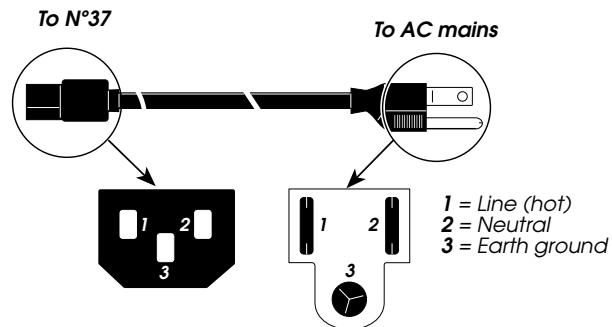

Turn on the power by pressing the top of the power switch above the power cord receptacle (it has a solid vertical line to indicate “on”: I.) Do not switch power off and on rapidly, as this interrupts the normal power-up sequence. We advise waiting at least five seconds between power cycles.

2 COMMUNICATION PORTS

These communications ports allow the N°37 to “link” to certain compatible Mark Levinson components. (See “*Linked Functions.*”)

The Mark Levinson Linking system provides for inter-component communications. Using the digital processor as the “master” of the system, other components such as digital transports and preamplifiers may be “daisy-chained” from the master, and information may be shared among all of the components on the daisy-chain. (The master acts as a central clearinghouse for that information.)

Thus, if the only other Mark Levinson Link-compatible component you have is the N°36 (for example), connect its **master** port to the N°37’s **slave in** port using a “straight-through” modular cable. Subsequent Link connections among source components are made from one component’s **slave out** port to the next component’s **slave in** port, continuing the “daisy chain.” If there is a Mark Levinson Link-compatible preamplifier in the system, place it at the end of the chain of line-level components by connecting the last source component’s **slave out** port to the preamplifier’s **slave** port. See the diagram at left for clarification.

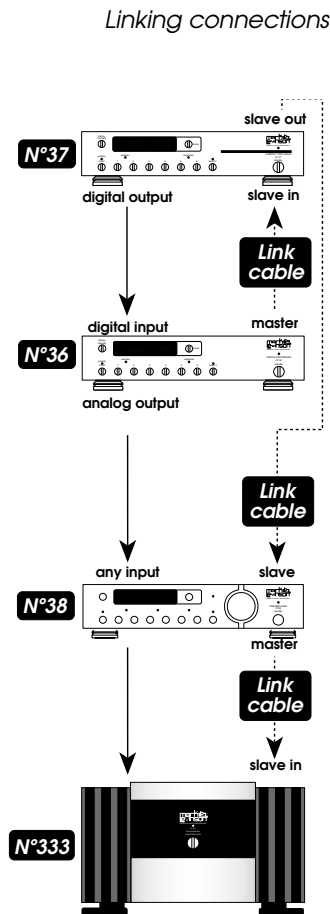

Important: If a compatible Mark Levinson preamplifier (such as the N°38 or N°38S) is Linked, it must be the last of the line-level components in the daisy chain. (Technically, it serves to terminate the communications bus used by the source components.)

Electrically, the Link connection between the preamplifier and the power amplifier(s) in the system is independent of the communications Links between various source components and the preamplifier. It may be used or not, regardless of whether the source components form a complete Communications Link system.

The modular cable needed for the Link connection between the N°37 and other Link components may be purchased from your Mark Levinson dealer. It may also be easily and inexpensively made to length using two modular connectors and the appropriate length (up to 100 feet/30 meters) of flat, eight conductor cable.

Modular cables and connectors are used throughout the world for both telecommunications and computers, and are widely available at low cost. The connectors are crimped on to the ends of the cable such that pin 1 at one end is connected to pin 1 at the other end. Such a “straight-through” connection is (counter-intuitively) made by introducing a 180° twist in the cable between the two ends, as shown below.

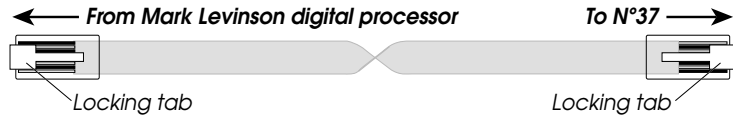

3 EXTERNAL IR INPUT

The N°37 incorporates an infrared repeater input to facilitate a wide range of installation options. If desired, the N°37 may be placed inside a cabinet or outside the normal line-of-sight in the listening area, with the controlling IR signal being relayed to the N°37 by any of a number of commercially-available IR repeaters.

The specifications for this IR input call for a triggering voltage of 5-12 volts at no more than 100 milliamperes of current, with the tip of the 1/8" mini-plug having positive polarity, as below:

IR input tip polarity

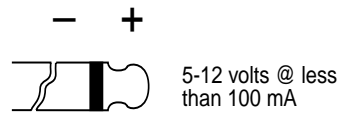

If you would like more information on the possibility of using an infrared repeater with your N°37, please contact your Mark Levinson dealer.

4 AES/EBU DIGITAL OUTPUT

This output provides the **digital audio signal (DAS)** via cables equipped with XLR-type connectors to the digital audio processor.

This input conforms to the Audio Engineering Society/European Broadcast Union (AES/EBU) professional digital audio standard, which calls for a 110Ω transmission of the DAS. Use a digital interconnecting cable specifically designed for the 110Ω AES/EBU standard, such as Madrigal MDC-1 cable, when using this input, with pin assignments as indicated below:

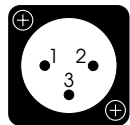

- Pin 1: Chassis ground
- Pin 2: non-inverted digital
- Pin 3: inverted digital
- Connector ground lug: chassis ground

It has been Madrigal's experience that the AES/EBU interconnection standard offers the best quality of all digital transmission interfaces when fully optimized, and we recommend its use wherever possible between Mark Levinson components.

However, optimizing any digital interface completely represents a significant engineering challenge. It is entirely possible that a different type of input may actually outperform a less-than-optimized AES/EBU implementation on some brands of digital processors. For this reason, we have gone to great lengths to fully optimize all four of the digital outputs on the N°37. If you are using you N°37 with a different brand of processor, we recommend experimenting to determine which type of input on that processor results in the best audible performance.

5 BNC S/PDIF ELECTRICAL DIGITAL OUTPUT

This output provides the **digital audio signal (DAS)** via cables equipped with BNC-type connectors to the digital processor.

This input conforms to the Sony/Philips Digital Interface Standard (S/PDIF), which calls for a 75Ω transmission of the DAS. Use a digital interconnecting cable specifically designed for the 75Ω S/PDIF standard, such as Madrigal MDC-2 cable, when using this input. (In our experience, a BNC-terminated S/PDIF cable has a slight advantage over the same cable terminated with RCAs. This is probably due to the fact that a BNC connector has a true 75Ω impedance, whereas RCA connectors cannot.)

6 RCA S/PDIF ELECTRICAL DIGITAL OUTPUT

This output provides the **digital audio signal (DAS)** via cables equipped with RCA-type connectors to the digital processor.

This input conforms to the Sony/Philips Digital Interface Standard (S/PDIF), which calls for a 75Ω transmission of the DAS. Use a digital interconnecting cable specifically designed for the 75Ω S/PDIF standard, such as Madrigal MDC-2 cable, when using this input.

7 ST OPTICAL DIGITAL OUTPUT

This output provides the **digital audio signal (DAS)**, via optical cable equipped with the ST-type optical connector (sometimes called "AT&T") to the digital processor.

Remote Control, N°37

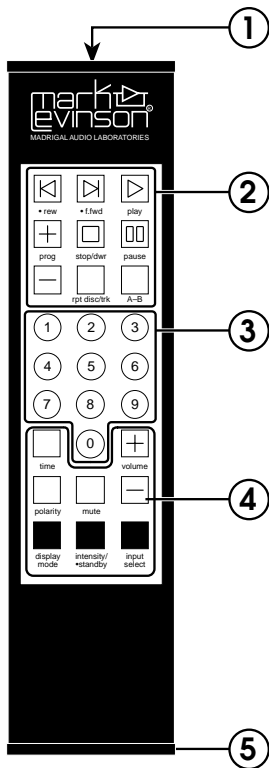

1 IR TRANSMITTER WINDOW

The N°37's Remote Control sends infrared (IR) commands through its projection lens, and the N°37 receives IR commands through its Remote sensor window. (See "Front Panel, N°37"). If either of these lenses is obstructed, no IR commands can be received by the N°37. If you notice IR performance deteriorating, you may want to clean these lenses with a soft cloth and some glass cleaner. (Spray the cleaner on the cloth first, and then wipe the lens with the moistened cloth. Do not spray the cleaner directly on either lens, as this may allow moisture to migrate into the electronics behind the lens assemblies.)

2 TRANSPORT & PROGRAMMING BUTTONS

The buttons used for routine operation of transport functions on the N°37 are grouped at the top of the remote control. They include:

- (◀) **•rew**: When pressed and released quickly, this will take you to the beginning of the **previous** track. (◀ is the international symbol for *previous*). When pressed *and held* (denoted by the bold dot •), the N°37 will enter a reverse audible scanning mode similar to the familiar *rewind* function of many cassette decks, allowing a precise location within a track to be located.
- (▶) **•f.fwd**: When pressed and released quickly, this will take you to the beginning of the **next** track. (▶ is the international symbol for *next*). When pressed *and held* (denoted by the bold dot •), the N°37 will enter a fast forward audible scanning mode similar to the familiar *fast forward* function of many cassette decks, allowing a precise location within a track to be located.
- (▶) **play**: Press to enter the **play** mode from either **stop**, **pause** or **standby**, or to restart play at the beginning of the track currently playing.
- (+) **prog**: Press while the disc is stopped to add a selected track to your programmed playlist (see *Programming the N°37* for more information).
- (■) **stop/dwr**: Press to **stop** play. The same button will operate the **drawer** if stopping the disc has no relevance (e.g., if it is already stopped, or if there is no disc inside the N°37).
- (||) **pause**: Press to **pause** play in the current location. If left in **pause** mode for more than two minutes, the N°37 will enter **extended pause** mode, shutting down both the laser and the drive motors to enhance longevity and reliability. Upon pressing **pause** or **play** a second time, the disc will spin up and begin playing from the location where it had been paused.
- (-) **prog**: Press while the disc is stopped to delete a selected track from your playlist, in "omission" programming (see *Programming the N°37* for more information).

rpt disc/trk: Press once to enter **disc repeat** mode (repeating the entire disc, or an entire playlist if one is entered). This action will illuminate the **disc repeat LED**. Press a second time to enter the **track repeat** mode (repeating a single track ad nauseum). A third press will cycle you back to normal operation, as will pressing **stop**.

A-B: Press once to establish a beginning point (point **A**) for an endless playback loop. The display will flash the letter **B** to indicate that it is ready to accept your designated ending point (point **B**). Once this has been done, the N°37 will repeat the segment of the disc between points **A** and **B** until you press **A-B** again, or **stop**. (Note that **A** must precede **B** on the disc.)

Accessing a point *after* the endpoint of the A-B loop by using **next**, **direct track** or **direct time** will also disengage the A-B function, entering normal **play** at your selected point. Using either **previous** or **direct time** access *prior* to point A will leave the A-B loop active: when you play back into the loop, it will reinstate itself. (*This is helpful when learning to play a particular segment of music, since you can “back up” to hear the lead-in to the segment occasionally without losing your A-B points.*)

3 NUMERIC KEYPAD

The numbers 0, 1, 2, 3, 4, 5, 6, 7, 8, and 9 may be used to directly access individual track numbers of discs played by the N°37. For example, to go directly to track 13, press **1** followed by **3**, and then press **play**. You do not have to add a 0 before a single-digit track number: **7**, followed by **play**, will take you directly to track number 7. (In fact, if the N°37 is already in play, simply pressing the number button will be sufficient.)

The N°37 displays a certain amount of intelligence with respect to direct track access. If the first number entered identifies a particular track unambiguously (such as **2** on a 12-track disc), the N°37 is “smart” enough to immediately move to that track. If the first number entered could be the first of two digits (such as **1** on a 12-track disc), the N°37 will wait for a moment to determine whether you wish to enter a second number. If not, it will then go to the single-digit track you selected.

Random Play

Incidentally, if you press **0** followed by **play**, the N°37 will enter a **random play** mode in which the order of the current disc’s playlist is scrambled, and then played. The first character of the display (that shows a **P** when playing a playlist) will show **R** to indicate **random play**. Moreover, placing the N°37 into **random play** mode while the **disc repeat** function is engaged will cause it to play the various tracks on the disc randomly indefinitely (until you stop it). This can be a great way to provide background music during a dinner party, for example.

These numbers may also be used in conjunction with other features, such as programming and direct access by time. For example, when in the **stop** mode, you may press **5** and press the **prog -** button to delete track 5 from your playlist. In this case, the N°37 would play that particular disc normally, except that it would automatically skip from track 4 to track 6.

Selecting a particular track does not affect the operating mode. That is to say, pressing **7** while in **play** begins playing track 7; pressing **4** while in **pause** leaves you paused at the beginning of track 4.

4 OTHER OPERATIONAL BUTTONS

time: Pressing this button (followed by appropriate numbers from the numeric keypad) allows direct access to any particular time on a disc. Note that this is a context-sensitive control—the time accessed will be according to the currently selected time display mode, e.g., 30:00 with the **time remaining** and **time on disc** LEDs lit will take you to that point where thirty minutes remains to the end of the disc.

(+) **volume:** Pressing this button on the N°37 remote control will transparently and automatically raise the volume of a Linked Mark Levinson preamplifier, minimizing the need to juggle multiple remotes. Since this function depends on the ability of the N°37 to pass the instruction to the N°38 (for example), the two components must be connected by a Link cable, and operate within a system which has a “master” digital processor. (See *Linked Functions* for more information.)

polarity: Pressing this button on the N°37 remote control will transparently and automatically invert the polarity of a Linked Mark Levinson digital audio processor, minimizing the need to juggle multiple remotes. Since this function depends on the ability of the N°37 to pass the instruction to the N°36 (for example), the two components must be connected by a Link cable. (See *Linked Functions* for more information.)

mute: Pressing this button will engage the **mute** of a compatible Mark Levinson preamplifier without stopping the transport. Pressing it a second time will restore the volume to its previous setting. Since this function depends on the ability of the N°37 to pass the instruction to the N°38 (for example), the two components must be connected by a Link cable, and operate within a system which has a “master” digital processor. (See *Linked Functions* for more information.)

(-) **volume:** Pressing this button on the N°37 remote control will transparently and automatically lower the volume of a Linked Mark Levinson preamplifier, minimizing the need to juggle multiple remotes. Since this function depends on the ability of the N°37 to pass the instruction to the N°38 (for example), the two components must be connected by a Link cable, and operate within a system which has a “master” digital processor. (See *Linked Functions* for more information.)

display mode: Pressing this button duplicates the function of pressing the mode button on the N°37, cycling through the four **time modes** (*time elapsed* or *time remaining*, either on the *track* or on the *disc*). *Pressing and holding* this button will allow you to set your Link options. (See *Linked Functions* for more information.)

intensity/•standby: Pressing this button momentarily cycles the N°37 (and any Linked Mark Levinson components) through their four levels of **display intensity** (bright, medium, dim, off). When pressed *and held* (denoted by the bold dot •), this button will place the N°37 into or out of **standby**.

input select: Pressing this button on the N°37 remote control will transparently and automatically cycle through the various active (e.g., *not* named **NOT USED**) digital inputs on a Linked Mark Levinson digital processor, minimizing the need to juggle multiple remotes. Since this function depends on the ability of the N°37 to pass the instruction to the N°36 (for example), the two components must be connected by a Link cable. (See *Linked functions* for more information.)

Analog Input Switching

Alternatively, you may force the **input select** button to select from among your *analog* inputs on a Linked Mark Levinson preamplifier by pressing and holding the button until it shows **DIGITAL**, then clicking the button to change it to **ANALOG**, and then pressing and holding the **input select** button a second time to confirm your change. (You may change it back at any time by reversing this procedure.)

5 BATTERY COMPARTMENT

The two AA batteries used by the Remote Control must be placed inside the compartment at the bottom of the remote's housing. Using the hex wrench provided in your accessory kit (look inside the slot within the foam rubber), carefully remove the two screws on the bottom of the housing and insert the batteries, being careful to orient them as indicated inside the battery compartment. Then replace the screws using the hex wrench.

Conditions that Affect IR Performance

IR communication between the Remote Control and the N°37 can be affected by:

- Direct sunlight
- Interior lighting
- Wall, window, ceiling, and floor treatments
- The angle of the Remote Control relative to the N°37

If the N°37 will be subject to direct sunlight, place it no more than 10 feet from where you'll normally operate the Remote Control. Where bright sunlight virtually floods the room, IR communication may be inconsistent.

In a room lighted primarily with incandescent fixtures, place the N°37 no more than 25-30 feet from where you'll normally operate the Remote Control. In a room with fluorescent fixtures, this range will be reduced. Where bright fluorescent lighting virtually floods the room, IR communication may be inconsistent.

IR, like visible light, reacts differently when it meets different surfaces. Carpeting and draperies, for example, tend to diffuse (scatter) IR and interfere with its transmission. Glossy or reflective surfaces, such as mirrors and smooth walls, "bounce" (reflect) IR and won't interfere with its transmission. When placing the N°37, it's important to account for potential IR bounce and diffusion. For example, in a room with thick carpeting, heavy draperies, and many pieces of furniture, you may need to place the N°37 closer to where you'll normally operate the Remote Control than you would in a sparsely furnished room with bare walls and hardwood flooring.

If possible, install the N°37 directly opposite from where you'll normally operate the Remote Control. In practice, the Remote Control will operate the N°37 at up to 30 degrees to either side of this direct line. To either side of this line, successful IR communication will depend on bounce and ambient lighting. (Please refer to diagram on next page.)

Optimum IR
reception window

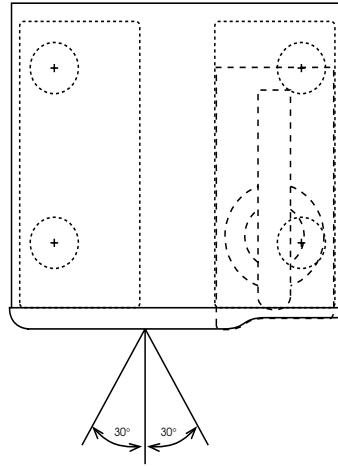

If the requirements of your installation preclude a clean line of sight between the N°37 and your listening position, you may want to consider using an infrared repeater to route the remote control's commands directly to the N°37, using the external ir input on the rear panel. (See item #3 in *Rear Panel, N°37*.) Please ask your dealer for more information on third-party IR repeaters.

Setup and Installation

Caution!

For your protection, review “Important Safety Instructions” before you install your N°37.

Connecting AC Mains

Plug the female end of the AC power cord into the appropriate socket on the rear panel of the N°37, being certain to seat it firmly, all the way into the receptacle.

Double-check to make sure that the AC power switch is in the off position (the side of the switch with an “O” should be depressed), and also that the voltage indicated on your N°37 corresponds to the normal voltage for your country. (Connecting a 120-volt N°37 to a 220-volt AC outlet is *not* a good idea.)

Plug the male end of the power cord into the wall outlet, and then turn on the power switch located on the rear panel of the N°37 (by depressing the side of the switch that has a single vertical line like this: “I”)

Making Digital Audio Connections

The N°37 incorporates **XLR**, **BNC** and **RCA** electrical output connectors, as well as an **ST** optical connector for providing the digital audio signal (DAS) to the digital audio processor. (See *Rear panel, N°37*, above.)

For electrical digital interconnection, we recommend Madrigal MDC cable. MDC-1 is designed for 110 Ω **AES/EBU** interconnection (via XLR connectors); MDC-2 is designed for 75 Ω **S/PDIF** interconnection (via either RCA or BNC connectors). Both cables are available in various lengths from your Mark Levinson dealer.

Using an appropriate cable, connect an output of your N°37 to a suitable input of your digital processor.

Making Link Connections

The N°37 incorporates sophisticated inter-component communications capabilities when Linked to compatible Mark Levinson components. (See “Communications Ports” in *Rear panel, N°37*.) If you own compatible Mark Levinson components, connect them to the N°37 with an eight-conductor modular cable as described on page 21. You may find that you need to cycle power off and on once after making this connection for the first time (if making the connection to a previously operating component), in order to ensure that all components in the chain are aware of each other’s presence. Engaging **PLAY** on the transport once from **STOP** will complete the Link connection by activating the communications bus between the components.

To help with special installations and custom cabinetry, drawings are included in this manual. (See *Dimensions*).

Basic Operation

Before operating your N°37, take a minute to become familiar with its controls and their locations. (See “*Front Panel*” and “*Remote Control*.”)

Loading a CD

To load a CD:

1. Make sure that the **main power** switch is set to the “I” position.
2. Enable the N°37’s controls by pressing **standby** if in standby.
3. Press **stop/drawer** to open the drawer.
4. Place a CD into the recess of the drawer, label side up. Handle the CD by the outer edges and center hole only.
6. Press **stop/drawer**.

Note: If you have previously saved a program for the CD, the letter **P** will appear preceding the track number on the display. (See “*Programming the N°37*.”)

*To override a previously saved program, briefly press **program** – once. All of the CD’s tracks will be accessible for basic operation, but the program will still be retained in the N°37’s memory.*

Playing a CD

To play all tracks on the CD, press the **play** button. All tracks will play in order. Play will stop automatically at the end of the CD.

To begin play with a track other than the first track:

1. Before pressing **play**, press **next** until the number of the desired track shows on the Display. If you pass the track you want to play, you can “back up” by pressing **previous**. (You may also select the track using the numbered buttons on the Remote Control.)
2. Press **play** to begin playing that track. The remaining tracks will play in order. Play will stop automatically at the end of the CD.

To return to the beginning of a track while it is playing, press **play**. Play will be suspended briefly, then that track will replay followed by the remaining tracks on the CD.

Random Play

Using the Remote Control, you may have the N°37 play tracks totally at random. To do this, press the **0** (zero) numbered key, then press **play**. The display will show **RANDOM** briefly to indicate that you have entered the random-play mode. Subsequently, the letter **R** will appear preceding the track number in the display as a reminder. To cancel random play, press **stop**.

Navigating the Disc

You may skip to another track any time while a CD is playing. To move to another track, press **next** (to go forward) or **previous** (to go backward) until the number of the track you want to play shows on the Display. (You may also select the track using the numbered buttons on the Remote Control.) Play will resume as soon as the pickup reaches that track.

You may search for a particular passage on the CD using **fast forward** and **rewind**, by *pressing and holding* the **next** and **previous** buttons (respectively). Use the reduced-volume audible scan available during these modes to search the CD until the laser pickup reaches the passage you want to hear.

As soon as you release the button, play resumes.

If you search past the beginning or end of a track, the laser pickup will move on to the previous (or next) track. If you try to search forward past the end of a CD or program, the laser pickup will stop at the end of the last track. If you try to search backward past the beginning of a CD or program, the laser pickup will stop at the beginning of the first track of the disc (or playlist).

Direct Time Access

You may use **time** on the Remote Control to begin play at a specific *time* on the disc.

1. Select the desired track using either **next** and **previous** or the **numeric keypad** on the Remote Control.
2. Press **time**, then press the numbered buttons corresponding to when you would like play to begin. (The numbers you select will appear in the **time** portion of the display.)
3. To begin play at that point, press **play**. (To pause the disc at the same point, press pause instead of play. This allows for extremely precise “cueing up” of a disc when making a recording, for example.)

Note: The time you select depends on the selection you've made with the display mode button: elapsed or remaining, CD or track.

For example, if you want to begin play one minute and thirty seconds into track 2, select track 2 by pressing **2** on the remote control. Press **time**, enter **1 3 0**, then press **play**. (This example assumes that the most recently used display mode was *elapsed time on track*.) If you do not press **play**, the N°37 will timeout after ten seconds (that is, it will “forget” that you had begun to do something, and revert to normal operation).

Alternatively, you might want to set the N°37 to play music for a specific period of time. Say you'd like to listen to music until the evening news begins in 30 minutes. Make sure both the **time on disc** and **time remaining** LEDs are on (indicating *time remaining on disc*, the default display mode when in stop); press **time**; enter **3 0 0 0**; and press **play**. This sequence will direct the N°37 to a point 30 minutes from the end of the disc, and engage play at that point. When the music ends, you will know it is time to turn on the news.

Pause

To suspend play while a CD is playing, press **pause**. To resume play at the same point, press **pause** again, or press **play** (either will work).

After about two minutes in pause, the N°37 will go into an “extended pause” mode, showing **X-PAUSE** briefly in the display. Extended pause stops the disc and turns off the laser against the possibility that you have been called away and may not return for some time. The N°37 will slowly flash the double bars (⏸) to indicate that you are in the **extended pause** mode rather than normal pause.

Alternatively, **extended pause** may be engaged by pressing *and holding* the **pause** button until **X-PAUSE** is displayed. Pressing **pause** again (or **play**) will re-

sume play at the point where **pause** was first pressed, (after a short delay to find the correct starting point, during which the display shows **SCANNING**).

Repeat Disc To repeat (continuously) all tracks on a CD, press **repeat** until the **disc repeat** LED is lit. The display will also show **RPT DISC** momentarily, making it easier to confirm the change from across the room. To return to normal play, press **repeat** again two more times (to cycle through **track repeat** to normal **play**). Pressing **stop** will also restore the N°37 to normal (non-repeating) operation.

Repeat Track To repeat (continuously) the track in (normal) play, press **repeat** twice (to cycle through **disc repeat** to **track repeat**). While the track repeat function is active, the LED above the button is lit. The display will also show **RPT TRK** momentarily, making it easier to confirm the change from across the room.

This feature is helpful (for example) when trying to learn how to play a particular song by playing along with the disc. To learn sections of the song, you may want to use the Repeat A-B function described below. Once you have most of the sections learned, you can put them together with a track repeat.

Track repeat takes priority over other functions such as **next** and **previous**. To return to normal operation, press **repeat** again.

Repeat A-B To repeat (continuously) a specific phrase or passage on a CD (when learning how to play a favorite solo, for example), press **A-B** on the remote at the beginning of the passage you would like to repeat. At the end of the passage, press **A-B** on the remote again. The passage you selected will repeat continuously.

While the **repeat A-B** function is active, the letters **A** and **B** will alternate, preceding the track number on the display. To exit the A-B loop, press the **A-B** button again, or press **stop**. (Accessing a point beyond B with **next**, **direct track**, or **direct time** will also take you out of the **repeat A-B** function.) To restart at the beginning of the A-B loop, press **play**.

Polarity If your N°37 is linked to a compatible Mark Levinson digital processor via the **communication ports**, you may change the playback polarity. (See *Linked Functions*.) Press **polarity** on the N°37's Remote Control, and the N°37 will instruct the digital processor to invert polarity, and the CD will play with inverted polarity.

Playing "Index 0" A few CDs have recorded sounds in the space immediately preceding the songs themselves. This space is referred to as "Index 0" (as distinct from Index 1, which is where the track is normally thought of as "beginning.") From the factory, the N°37 is set to let you hear everything on the disc, including this so-called "Index 0" portion of each track.

To change whether or not Index 0 is audible, *press and hold* the play button for a few seconds, until the display reads **NDXØ OFF** or **NDXØ ON**. To toggle between on and off, click on the play button. When you have made your selection, press and hold the play button again until the display reads **SAVED**.

Programming the N°37

Introduction to Playlists

Rather than playing an entire CD, you may choose to play only certain selections. To do this, you create a “playlist.” If this is a one-time playlist, it may be used immediately upon being created (and will vanish when a new playlist is created). Alternatively, thousands of playlists may be stored in the N°37’s permanent memory, at which point each becomes the default playlist for the particular disc with which it is associated (until you explicitly change it).

Before using your N°37’s programming features, become familiar with its controls and their locations, as well as their basic functions.

***Note:** During the playing of a playlist, the N°37’s basic functions operate as described in “Basic Operation,” except that they affect the playback of the **program**, not the entire CD. For instance, pressing **next** during play skips to the next track in the playlist, whether or not it is the next track on the CD. In the same way, engaging **disc repeat** will repeat the entire **playlist**, not the entire disc.*

The N°37 allows up to 99 selections per playlist, with any given track appearing once only. In practical terms, the only limitation on the length of your playlist is the number of tracks on your disc.

Important Note:

Assembling a playlist is possible only when the disc is stopped.

The N°37’s memory can store playlists for thousands of different CDs. Saved playlists remain in memory when you place the N°37 into **standby**, when you turn off the **main power** switch — even if AC power is interrupted.

When you load a CD, the N°37 reads its unique identification code. If you assemble a playlist for a particular CD **and** save it into the N°37’s memory, the N°37 “remembers” that CD’s playlist.

The next time you load that CD, the N°37 will recognize the CD’s identification code and automatically load the previously saved playlist. (The display initially shows the number of tracks and total time on the *disc*, followed by the number of tracks and total time of the *playlist*, preceded by the letter **P** in the display.)

Even if you have previously saved a playlist for a CD, the N°37 allows you to temporarily override it (and have access to all tracks on the CD), without erasing it from memory. This temporary override applies to polarity programming as well (see p. 35).

To temporarily override a previously saved playlist, press **program** — while the CD is loaded but before play has started. All of the CD’s tracks will subsequently be accessible for normal operations, but the original playlist will still be retained in the N°37’s memory. You can even create a temporary playlist as an alternative to your normal, permanent playlist.

Assembling a Playlist

To assemble a new playlist:

1. Load a CD, and wait for the display to show the number of tracks and their total playing time.
2. Using the **next** and **previous** buttons (or the numbered buttons on the Remote Control), select the first track in your playlist.
3. Add the first selection to your playlist by pressing **program +**. The display will acknowledge your command by showing a “plus” sign (+) preceding the track number on the display to indicate that it has been added to the playlist.
4. Assemble the rest of your playlist by repeating steps 2 and 3. Make sure to press **program +** after each selection.

Programming by Omission

If you want to play *most* of a CD, and just “omit” a few tracks, you may want to use this shortcut:

1. Load a CD, and wait for the display to show the number of tracks and their total playing time.
2. Using the **next** and **previous** buttons (or the numbered buttons on the Remote Control), select the first track you want to *eliminate* from your program.
3. “Omit” the track by pressing **program -**. This action both places the N°37 in its program mode and deletes the track from the current playlist. The display will advance to the *next available track* remaining in the playlist. A plus sign (+) will be displayed next to that track number to indicate that it is still *in* the playlist.
4. Using **next** and **previous**, move to any other tracks you would prefer to skip, pressing **program -** to eliminate each track from the playlist. Once you are in the program mode, a plus sign (+) will illuminate to indicate a track is in the playlist, and extinguish for any track omitted from the playlist.

Saving a Playlist

Once you have created the playlist you want for a particular disc, you may either use it as a temporary playlist (using it only for that one occasion), or save it as the default playlist for that disc. To save a playlist:

1. When you’ve finished adding selections, you can save the new playlist by pressing *and holding* the **program +** button.
2. The N°37 will confirm that your playlist is saved by displaying **SAVED** briefly (or **REVISED** if you changed an existing playlist).

Reviewing a Playlist

To review your playlist before playing it:

1. Load a CD for which you’ve already saved a playlist (the letter **P** will appear preceding the track number on the display); or load an unprogrammed CD, then assemble and save a playlist.
2. Without selecting any particular track (while the playlist’s total number of tracks and total playing time are displayed), press **program +**. The display will show the first selection in your playlist. For example, if track 3 is the first selection in your program, the Display would show **P3** and the time of track 3.
*Note: If you try to review a nonexistent playlist, the display will show **NO PGM**.*
3. To view the next selection, press **program +** again, and so on.
4. After you view the last selection, one more press of **program +** will cause the display to show **END PGM** momentarily, and then move on to show the first track in the playlist.

Deleting a Track from a Playlist

You may delete any selection from a playlist. To delete a selection:

1. Load a CD for which you've already saved a program (the letter **P** will appear preceding the track number on the Display); or load an unprogrammed CD, then assemble a program.
2. Press **program +**. The display will show the first selection in your program.
3. Press **program +** until the selection you want to delete appears on the display.
4. Press **program -**; the display will remove the plus sign (+) from the displayed track to indicate that it has been removed from the playlist.
5. Repeat steps 3 and 4 for each selection you want to erase from your program.
6. If you would like to make this change permanent, *press and hold* **program +** when you finish erasing selections from your program; the display will show **REVISED**.

Adding a Track to a Playlist

You also may add a selection to a previously saved playlist. To do so:

1. Load a CD for which you've already saved a playlist (the letter **P** will appear preceding the track number on the display); or load an unprogrammed CD, then assemble and save a playlist.
2. Using the **next** and **previous** (or the numbered buttons on the Remote Control), select the track you want to add to your playlist.
3. Add the selection to your playlist by pressing **program +**. Your new selection will be added to the end of your existing playlist.
4. Repeat steps 2 and 3 for each selection you want to add to your program. Make sure to press **program +** after each selection.
5. If you would like to make this change permanent, *press and hold* **program +** when you finish erasing selections from your program; the display will show **REVISED**.

Overriding a Playlist

When you load a CD, the N°37 reads its unique identification code. If you assemble a playlist for a particular CD *and* save it into the N°37's memory, the N°37 "remembers" that CD's playlist.

Even if you have previously saved a playlist for a CD, the N°37 allows you to temporarily override it (and have access to all tracks on the CD), without erasing it from memory. You can even create a temporary playlist as an alternative to your normal, permanent playlist.

To *temporarily* override a previously saved playlist, press **program -**. The **P** that denotes playlist will be turned off. (If you change your mind, simply press **program +** to restore the previously created playlist.) All of the CD's tracks will subsequently be accessible for normal operations, but the original playlist will still be retained in the N°37's memory.

Erasing Playlists from Memory

To *permanently* erase a previously saved playlist from the N°37's memory, *press and hold* the **program -** button; the display will show **ERASING**.

Why Polarity Programming?

During the recording process, the polarity of the recorded signal is typically inverted many times. If the total number of 180° inversions is even, the “net” polarity remains unchanged; if odd, a 180° polarity inversion is introduced. Some people are quite sensitive to this distinction. (The difference can be envisioned by imagining a kick drum being struck: the initial motion of the drum head is forward, forming a compression wave; if inverted, the initial transient would be reproduced as though the drum head had initially moved backward, creating a rarefaction.)

To complicate matters further, different portions of (or instruments on) the recording may experience even or odd numbers of inversions, resulting in no single “correct” playback setting. This problem is particularly common among multiple-microphone recordings. Ultimately, only you can decide whether one polarity setting sounds better than the other, and if so, which you prefer.

Fortunately, if the N°37 is Linked to a compatible digital audio processor (such as the N°36), the playback polarity of the processor will be known by the transport, and may be controlled by the transport’s remote control. Moreover, the N°37 can be asked to “remember” your preference for each recording (should you have one).

Important Note:

Programmed playlists include polarity information. The N°37 will ensure the “correct” polarity (that is, the polarity you chose when creating the program) upon playback of that playlist. This polarity may only be overridden by either temporarily overriding the playlist or by re-programming the playlist (see below). If you are sensitive to polarity—and many people are not—you will want to determine the correct polarity before creating your playlists.

Whole-Disc Polarity Programming

If you want to remember only the preferred polarity for an entire disc, and do not wish to store a custom playlist:

1 PRESS STOP

When in **stop**, the N°37 displays the total number of tracks and time on the disc. (If you have already saved a program, the track display will be preceded by a **P**, and indicate the total number of tracks and time of the program, not the disc. You must not have a preexisting program if you wish to save a single polarity for the entire disc in one step. To erase a preexisting program, press and hold the **program –** button.)

2 CHOOSE YOUR PREFERRED POLARITY

You may use either the **polarity** button on the processor or the **polarity** button on the N°37 remote control. (Remember: the two units must be connected by a Link cable for polarity programming to work.) Select your preferred setting.

**Track-by-Track
Polarity Programming**

3 PRESS AND HOLD THE PROGRAM + BUTTON

The display will show **SAVED** to indicate that it has saved your polarity program for the entire disc.

Some discs seem to flip back and forth in polarity between one track and the next. If you wish to store polarity on a track-by-track basis, follow the directions for assembling a playlist (above), selecting the polarity for each track after you are on that track, but before you press the **program +** button to add it to the playlist.

Similarly, you may “edit” the polarity of an existing program by pressing **stop** and then reviewing the playlist one track at a time. Change the polarity of any track you like while its information is being displayed, and then press and hold the **program +** button to revise the program.

Linked Functions

The N°37 has the ability to “link” several of its functions to compatible Mark Levinson components (like the N°36 Digital Audio Processor and the N°38 or N°38S Preamplifier, and the 30/300-series power amplifiers).

Note: To take advantage of linked functions, you must connect the N°37 to the other components via their communication ports. (See “Rear Panel” and “Setup and Installation.”)

The following linked functions are selected as operational options at the N°37 by pressing *and holding* the **mode** button until the display changes to show **SET** followed by **LINKS**. Subsequent clicks of the **mode** button will cycle through the various Link settings; having selected the option you would like to change, use the **program +** and **program –** buttons to turn various options on or off, respectively.

Standby link

■ **Standby link:** This feature links the standby modes of the various Mark Levinson Linked components. For example:

- If transport, digital processor, preamplifier and power amplifier(s) are in standby mode, pressing the transport’s **standby** button will take all four components out of standby mode (making them ready to use).
- If transport, digital processor, preamplifier and power amplifier(s) are “on” (not in standby mode), pressing the N°37’s **standby** button will place only the transport in standby mode (presuming that you may wish to use your digital processor with some digital source other than the N°37).
- If transport, digital processor, preamplifier and power amplifier are “on” (not in standby mode), pressing the *preamp’s* **standby** button will place all four components into standby mode.

Name link

■ **Name link:** The Mark Levinson digital transport’s name link automatically overrides the name setting for its input. When you select the N°37’s input on the processor, it will show **No37** on its display.

Play link

■ **Play link:** When you press the N°37’s **play** button, this link automatically selects the appropriate inputs on the digital processor and on the preamplifier so you can listen to the CD.

Display Link

■ **Display link:** This links the **display intensity** functions of the N°37 and the other Linked components. When the components are linked, all displays will be set to the same brightness. Pressing **display intensity** on any of the Linked components will affect all the displays.

Polarity link

■ **Polarity link:** This links the polarity button on the transport’s Remote Control to the **polarity invert** function of the digital processor. (If Linked, the playback polarity of the digital processor will be known by the N°37.) This Linked function is automatic, and cannot be turned off by the user (short of disconnecting the Link cable).

Changing Link Options

The following procedure will guide you through changing your Link options, should you decide you would like something other than the factory's default settings. (Note that most people are perfectly satisfied with the default settings, and never need to concern themselves with this section.)

1. Make sure that the **main power** switch is set to the "on" ("I") position and the unit is not in "standby." *Note: To change your N°37's link settings, your Mark Levinson digital processor also must be connected (Linked) and turned on.*
2. Press *and hold* the front-panel **mode** button until **SET** followed by **LINKS** appears on the display. Release the **mode** button; subsequent "clicks" of the **mode** button will cycle through each of your N°37's options, in this order:

STDBY +

NAME + (+ indicates that the option is turned **on**)

PLAY + (– indicates that the option is turned **off**)

DISP +

Continued clicks on the **mode** button will return you to the beginning of the list, in case you accidentally pass the option you want to change.

(Note that the Polarity Link is always on and cannot be disabled, other than by disconnecting the Link cable.)

3. When the display shows the link setting you want to change, you may turn the link **on** by pressing the **program +** button; to turn the link **off**, press the **program –** button.
4. Repeat step 4 for each link setting you want to change.
5. When you have finished, press *and hold* the **mode** button again to confirm your change(s). The display will read **SAVED**.

Your link settings remain in memory when you place the N°37 into **standby**, when you turn off the **main power** switch — even if AC power is interrupted.

Auto-Standby

The N°37 also may be set to automatically enter standby when left in stop for a user-selectable period of time. As shipped from the factory, its standby function is manual (that is, it only enters or leaves standby when told to do so by the user). To change between manual and timed/automatic standby:

1. Press *and hold* the **standby** button until the display reads **MANUAL**.
2. Release the **standby** button and then "click" it to cycle through the various options: **5 MIN**, **15 MIN**, **30 MIN**, **60 MIN**, and **MANUAL**. Select the mode you want.
3. Press *and hold* the **standby** button again until the display reads **SAVED**.

Using Learning Remote Controls

The N°37 includes both an infrared receiver *and* an infrared transmitter. With this capability, it can “teach” a learning remote control any commands that might be needed for remote operation.

Specifically, the N°37 can send all of the necessary IR commands from its **display** window, enabling you to teach a learning remote any or all of its pre-programmed commands, as well as some optional special commands that are available to solve specific installation-related problems.

The N°37 has two special modes of operation into which it may be placed in order to facilitate the “teaching” of remote control commands to a learning remote control. The first allows you to easily teach the commands for which there are corresponding front panel buttons. The second allows you to teach “special” commands to the remote control for which there are no corresponding front panel buttons.

Teaching N°37 Front Panel Commands

1 PRESS AND HOLD THE REPEAT BUTTON TO ENTER THE FRONT PANEL TEACHING MODE

The display will show **<TEACH IR** to indicate that the N°37 is ready to teach a learning remote control the infrared commands that correspond to its front panel buttons. The left-pointing arrow points directly at the point from which the IR commands will be sent, to assist you in lining up your learning remote control.

If you change your mind, simply don't touch *any* button for ten seconds and the N°37 will return to normal operation. (*Hint:* you may remember that this special “hidden” feature of the N°37 is accessed via a press-and-hold of the **repeat** button by associating its use with the external IR “repeaters” so often used in custom installations; the functionality found here is of most value in such installations.)

2 PRESS ANY FRONT PANEL BUTTON TO CAUSE THE N°37 TO SEND THE CORRESPONDING IR COMMAND

Line up the IR window of your remote control with the left side of the N°37 display, at a distance of approximately 2"-6". Select the to-be-learned button on the remote, then press the corresponding button on the N°37 to fire the appropriate IR code. The left-pointing arrow in the display will change to an upward-pointing arrow to indicate the sending of the IR signal: **^TEACH IR**. When it reverts to left-pointing, it is ready to issue the next command to be learned.

Most learning remotes need to be held fairly still while they learn new IR commands; movement can garble the received IR. If you are uncertain as to how to prepare your remote control for learning new commands, refer to the instructions provided with the remote control.

3 REPEAT THE PROCESS OF “TEACHING” NEW COMMANDS TO THE VARIOUS BUTTONS ON YOUR REMOTE CONTROL UNTIL ALL APPROPRIATE OR DESIRED FRONT PANEL COMMANDS HAVE BEEN LEARNED BY YOUR REMOTE

4 WHEN FINISHED, EXIT THE TEACH IR MODE BY ALLOWING THE N°37 TO “TIMEOUT”

You may wish to teach your remote control some of the N°37's special commands (those for which there is no corresponding front panel button); in this case, you should go directly to the next section. Otherwise, simply avoid pressing any buttons for about ten seconds, and the N°37 will automatically return to normal operation.

At some point, however, you should test all your newly “learned” commands to ensure that they were “learned” correctly.

**Teaching Other
N°37 Commands**

As mentioned above, the N°37 has the capability to teach learning remote controls special commands for which there are no front panel counterparts. These commands can be especially helpful in solving problems in certain kinds of custom installations.

These “positive control” commands in the N°37 will place it into a certain mode of operation regardless of its current state. For example, a positive control command to enter **standby** will *leave* the N°37 in **standby** if already there, or *switch* it to **standby** if it is currently operating. This type of positive control is especially helpful when you do not necessarily know the current status of the N°37, as might be the case in a multi-room home entertainment system (for example).

1 PLACE THE N°37 IN ITS FRONT PANEL TEACHING MODE

As explained on the previous page, you do this by pressing and holding the **repeat** button until the display reads **TEACH IR**. If no further buttons are pressed within approximately ten seconds, the N°37 will “time out” and return to normal operation.

2 RELEASE, THEN PRESS AND HOLD THE REPEAT BUTTON A SECOND TIME TO PLACE THE N°37 IN ITS CUSTOM IR MODE

After about five seconds, the display will change from **TEACH IR** to **CUSTOM IR**. This indicates that the special IR codes that do not correspond to front-panel buttons are now available for teaching to a learning remote control—including some that are designed to solve problems unique to custom installations.

3 PRESS THE PROGRAM + BUTTON REPEATEDLY TO ADVANCE TO THE DESIRED FUNCTION

The table on the next page lists the various commands that are available for the N°37 for which there is no front-panel equivalent. In some cases, they represent “positive control” alternatives to commands which normally toggle between two settings (such as standby and operate). In other cases, they represent functions which exist only on the remote control. In the second column are the designations that will be displayed to indicate that the N°37 is ready to fire the corresponding IR code.

special commands table

Pressing **program +** will advance you to the next command in the table; pressing **program -** will back up to the previous command in the table. If no button is pushed for more than ten seconds, the N°37 will “time out” and return to normal operation.

Command	Display
positive control for operate	OPERATE
positive control for standby	STANDBY
display intensity to high	DISP HI
display intensity to medium	DISP MED
display intensity to low	DISP LOW
display intensity to off	DISP OFF
A-B repeat	RPT AB
Numeric Keypad: 1	#1
Numeric Keypad: 2	#2
Numeric Keypad: 3	#3
Numeric Keypad: 4	#4
Numeric Keypad: 5	#5
Numeric Keypad: 6	#6
Numeric Keypad: 7	#7
Numeric Keypad: 8	#8
Numeric Keypad: 9	#9
Numeric Keypad: 0	#0
Direct Access by Time	TIME
Polarity*	POLARITY
Volume Increment*	VOL +
Volume Decrement*	VOL -
Mute*	MUTE
Select Input*	INPUT
positive control for Stop	HRD STOP

*Note that these functions only apply to systems that include appropriate, Linked Mark Levinson components.

4 **MOMENTARILY PRESS THE REPEAT BUTTON TO TRANSMIT THE SELECTED CODE**

Line up the IR window of your remote control with the left side of the display of the N°37, at a distance of approximately 2"-6". Select the to-be-learned button on the remote, then fire the selected code from the N°37 by pressing **repeat**.

(If you are uncertain as to how to prepare your remote control for learning new commands, refer to the instructions provided with the remote control.)

5 REPEAT THE PROCESS OF “TEACHING” NEW SPECIAL COMMANDS UNTIL ALL DESIRED COMMANDS HAVE BEEN LEARNED BY YOUR REMOTE CONTROL.

If you take longer than approximately ten seconds between button pushes, the №37 will time out and return to normal operation. If this occurs, return to step #1 in this section. You may either cycle through the entire list by pressing **program +** repeatedly, or move backwards through the list by pressing **program -**.

6 WHEN FINISHED, RETURN TO NORMAL OPERATION BY ALLOWING THE №37 TO “TIME OUT”

The №37 will “timeout” and return to normal operation after approximately ten seconds.

Troubleshooting

In general, refer any service problems to your Mark Levinson dealer. Before contacting your dealer, however, check to see if the problem is listed here. If it is, try the suggested solutions. If none of these solves the problem, contact your Mark Levinson dealer.

1. THE N°37 WON'T FUNCTION, AND THE DISPLAY IS DARK.

- ✓ The unit is in standby. Press the **standby** button.
- ✓ The N°37 isn't plugged into the AC mains or the main power switch isn't turned on.
- ✓ The wall socket, adapter, or extension cord is faulty.
- ✓ There's a tripped circuit breaker or blown fuse in the wall outlet's circuit.
- ✓ A fuse is blown in your N°37 (contact your Mark Levinson dealer).

2. THE DISPLAY IS LIT, BUT THERE IS NO OUTPUT

- ✓ The proper source isn't selected on your digital processor.
- ✓ The proper source isn't selected on your preamplifier.
- ✓ The interconnecting cables are connected incorrectly or are faulty.

3. THE N°37 DISPLAY READS "NO DISC"

- ✓ There is no disc in the drawer for the transport to read.
- ✓ The disc is upside down and therefore cannot be read.
- ✓ The disc has loaded improperly and cannot be read—open the drawer, ensure that the disc is placed properly in the drawer, and try again.

4. THE N°37 WON'T PLAY A CD INSERTED IN THE PLAYER.

- ✓ The CD is inserted upside down.
- ✓ There may be condensation (moisture) on the laser pickup. This can happen if the N°37 is moved from a cold environment (such as a warehouse or a shipper's truck) to a warm one. Set the **main power** switch to its "I" position, and leave it on for one hour to warm up, then try playing a CD again.

5. WHEN A CD IS PLAYING, THE SOUND "SKIPS."

- ✓ The CD is severely scratched or dirty.
- ✓ The N°37 is on an unstable surface or is too close to your speakers.

6. THE LINKED FUNCTIONS DON'T WORK.

- ✓ There is no "master" on the Link system: a Mark Levinson digital processor serves as central clearinghouse of information being passed from one component to the next.
- ✓ The Link cable is disconnected, or is connected incorrectly. Check your Link connections, and then cycle between play and stop to make the processor aware that a N°37 has recently been connected on the Linking system.
- ✓ The digital audio cable is disconnected, or is connected incorrectly (in which case the Display Link function would continue to work correctly, but none of the others would work).

- ✓ Try turning off/disconnecting AC power from both the processor and the N°37. After several seconds, restore AC power to the digital processor, *then* turn on the N°37's **main power** switch. ***Never operate the main power switch without first making sure that power is turned off to your receiver, integrated amplifier, or preamplifier/power amplifier.***
- ✓ You may have older versions of the system software in your associated Mark Levinson components which do not fully support all Linked functions. Contact your Mark Levinson dealer with the model and serial numbers of your Mark Levinson components. If needed, new EPROMs will be provided at no charge.

7. THE REMOTE CONTROL DOESN'T OPERATE THE N°37.

- ✓ The Remote Control is at the wrong angle relative to the N°37, and the N°37 can't receive the signal.
- ✓ The sensor window on the front panel of the N°37 is dirty or blocked.
- ✓ The Remote Control's projection lens is dirty.
- ✓ Fluorescent lighting or sunlight is interfering with the operation of the Remote Control.
- ✓ The Remote Control's batteries are weak and need to be replaced.
- ✓ The Remote Control's batteries are installed incorrectly.

Care and Maintenance

To remove dust from the cabinet of the N°37, use a feather duster. To remove dirt and fingerprints, we recommend isopropyl alcohol and a soft cloth.

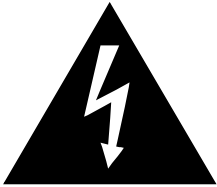

Caution!

Always apply the isopropyl alcohol to the soft cloth and then wipe the N°37 with the dampened cloth. Never pour or spray even small amounts of any liquid directly on the N°37, as doing so may allow the liquid to reach the circuitry inside the unit. Any liquid inside the unit poses a hazard to both the user and to the unit, and must be avoided.

Make sure that the Remote sensor window on the front panel and the Remote Control's projection lens are kept clean and dust-free.

Fluorescent lighting and sunlight may interfere with the operation of the Remote Control. Avoid placing the N°37 near fluorescent lamps or in direct sunlight.

When the Remote Control's batteries need to be replaced, use only AA batteries; always replace both batteries at the same time. If you don't plan to use the Remote Control often, remove the batteries. When not used for an extended period, even "leakproof" batteries can leak corrosive acids that will damage the Remote Control (and will void the warranty).

A CD, handled carefully, will last indefinitely. A warped, dusty, or scratched CD can cause playback problems, including audible skipping or other noises. Handle a CD by the outer edges only; if necessary, support it with your index finger at the center hole.

When you're finished playing a CD, always return it to its plastic case. Store your CDs where they won't be exposed to direct sunlight, high humidity, or extremely high or low temperatures.

U.S. and Canadian Warranty

90-Day Limited Warranty

This Mark Levinson® product is warranted to be free from defects in material and workmanship under normal use for a period of ninety (90) days from the date of purchase. **To extend the warranty of this Mark Levinson product**, return the warranty registration card along with a copy of the original receipt of purchase to Madrigal Audio Laboratories, Inc., P. O. Box 781, Middletown, CT 06457.

Five Year Extended Warranty

The **extended warranty** for this Mark Levinson product is **five (5) years** from the date of purchase. During the warranty period, any Mark Levinson component exhibiting defects in materials and/or workmanship will be repaired or replaced, at our option, without charge for either parts or labor, at our factory. The warranty will not apply to any Mark Levinson component that has been misused, abused or altered.

Any Mark Levinson component not performing satisfactorily may be returned to the factory for evaluation. Return authorization must first be obtained by either calling or writing the factory prior to shipping the component. The factory will pay for return shipping charges only in the event that the component is found to be defective as above mentioned. There are other stipulations that may apply to shipping charges.

There is no other express warranty on this component. Neither this warranty nor any other warranty, express or implied, including any implied warranties of merchantability or fitness, shall extend beyond the warranty period. No responsibility is assumed for any incidental or consequential damages. Some states do not allow limitations on how long an implied warranty lasts and other states do not allow the exclusion or limitation of incidental or consequential damages, so that the above limitation or exclusion may not apply to you.

This warranty gives you specific legal rights, and you may also have other rights which vary from state to state. **This warranty is applicable in the United States and Canada only.** Outside of the U.S. and Canada, please contact your local, authorized Mark Levinson distributor for warranty and service information.

Obtaining Service

We take great pride in our dealers. Experience, dedication, and integrity make these professionals ideally suited to assist with our customers' service needs.

If your Mark Levinson component must be serviced, please contact your dealer. Your dealer will then decide whether the problem can be remedied locally, or whether to contact Madrigal for further service information or parts, or to obtain a Return Authorization. The Madrigal Technical Services Department works closely with your dealer to solve your service needs expediently.



Important!

Return authorization must be obtained from Madrigal's Technical Services Department BEFORE a unit is shipped for service.

It is extremely important that information about a problem be explicit and complete. A specific, comprehensive description of the problem helps your dealer and the Madrigal Technical Services Department locate and repair the difficulty as quickly as possible.

A copy of the original bill of sale will serve to verify warranty status. Please include it with the unit when it is brought in for warranty service.



Warning!

All returned units must be properly packaged (preferably in their original packing material), and the proper return authorization numbers must be marked on the outer carton for identification. If the packaging to protect the unit is, in our opinion or that of our dealer, inadequate to protect the unit, we reserve the right to repackage it for return shipment at the owner's expense. Neither Madrigal nor your dealer can be responsible for shipping damage due to improper (that is, non-original) packaging.

Your dealer can order a new set of shipping materials for you if you need to ship your component and no longer have the original materials. There will be a charge for this service. We *strongly* recommend saving all packing materials in case you need to ship your unit some day.

Specifications

The correlation between published specifications and sonic quality is unreliable. A list of numbers reveals virtually nothing. All technical measurements must be subject to qualitative as well as quantitative interpretation.

Measurements of the N°37 yield excellent results by any standards. However, only those specifications that apply to its actual operation are included here.

- Direct digital output, XLR: AES/EBU 110Ω, 5V
- Direct digital output, BNC: S/PDIF 75Ω, 2V
- Direct digital output, RCA: S/PDIF 75Ω, 2V
- Direct digital output, ST: Hewlett-Packard® ST optical
- Mains voltage: 100V, 120V, 200V, 220V, 240V,
factory set for destination country only
- Mains frequency: 50 or 60 Hz,
factory set for destination country only
- Power consumption: 29 watts maximum
- Overall dimensions: See "Dimensions"
- Shipping weight: 34 lbs. (15.5 kg)
- Connector complement:
 - 1 male XLR-type connector
 - 1 female BNC-type connector
 - 1 female RCA-type connector
 - 1 ST-type optical connector
 - 2 RJ45 connectors
 - 1 IEC mains connector

Madrigal provides an owner-transferable, five year limited warranty on all Mark Levinson products within the U. S. and Canada ONLY. Warranty and service policies outside the U. S. and Canada are set by the local, authorized distributor and are applicable in the country of purchase ONLY. Madrigal products are designed to operate at set voltages appropriate for the country of sale and may be damaged if operated at the wrong voltage.

Dimensions

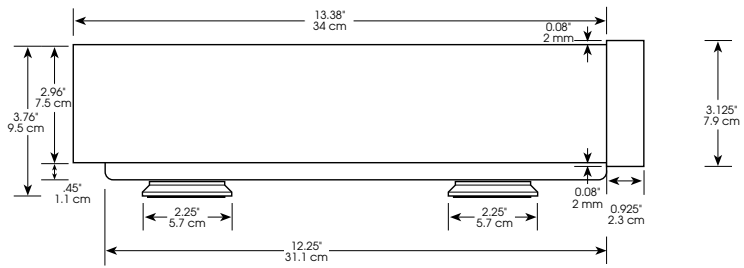
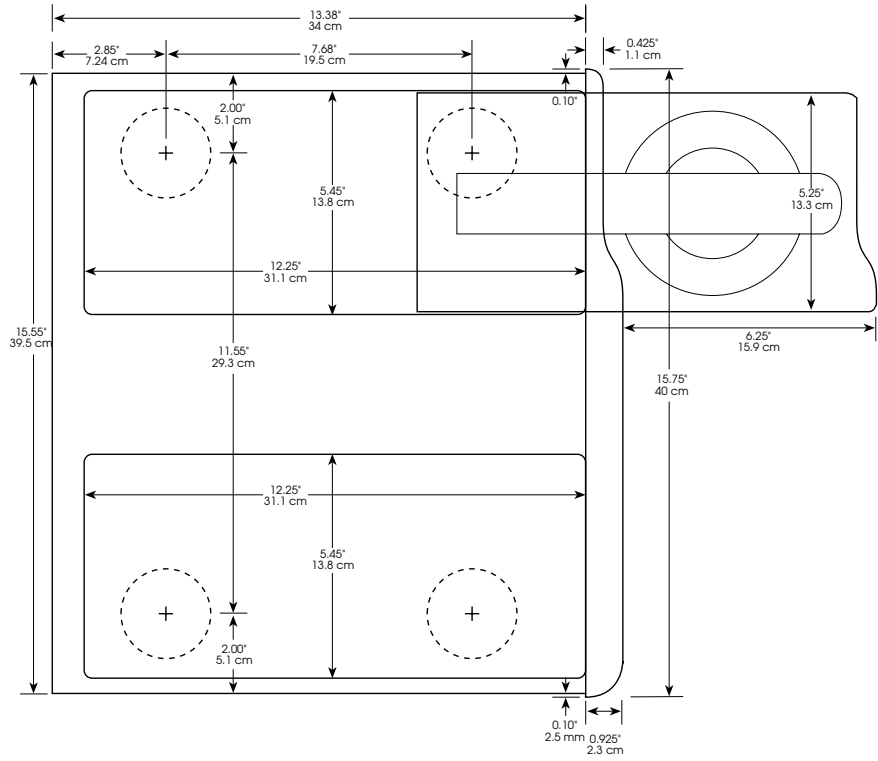



MADRIGAL

Madrigal Audio Laboratories, Inc.
2081 South Main Street, P.O. Box 781
Middletown, Connecticut 06457 USA

Telephone: (860) 346-0896
Fax: (860) 346-1540
<http://www.madrigal.com/>

mark
evinson[®]
MADRIGAL AUDIO LABORATORIES

is a registered trademark of Madrigal Audio Laboratories, Inc.
H a Harman International company